

103-H8221-6241

SANYO DENKI
SANMOTION

Dimensions (Unit:mm)

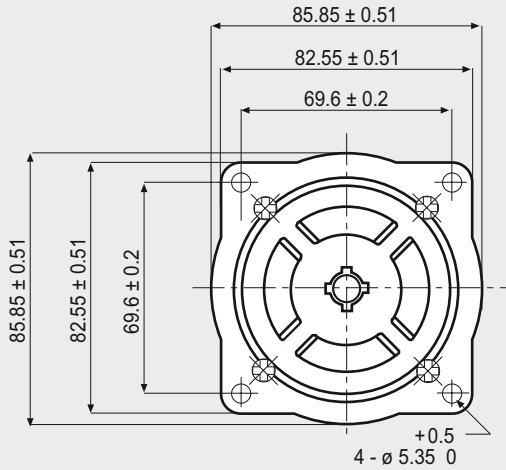

WIRES ARE HOUSED IN A VINYL TUBE.
T IS THE EARTH TERMINAL.

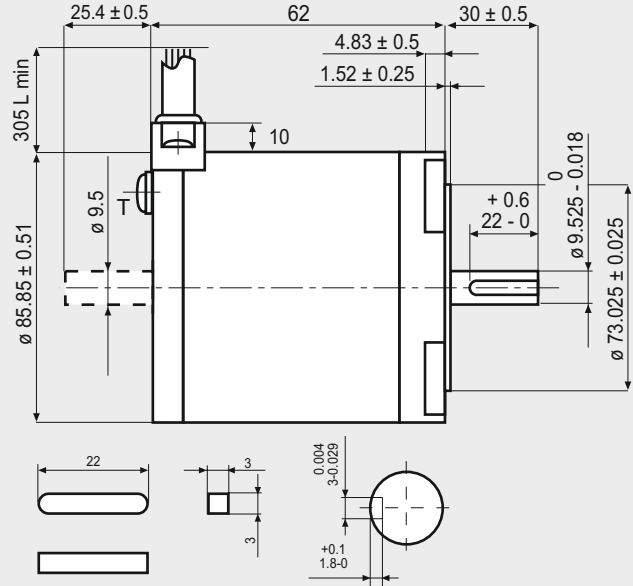

FEATURES

MODEL	103-H8221-6241 (103-H8221-6211)
BASIC STEP ANGLE	1.8° ± 0.09°
BIPOLAR CURRENT (Amp)	6.0
UNIPOLAR CURRENT (Amp)	
RESISTANCE (Ohm)	0.3
INDUCTANCE (mH)	1.65
BIPOLAR HOLDING TORQUE (Ncm)	300
UNIPOLAR HOLDING TORQUE (Ncm)	
ROTOR INERTIA (Kg ^m 2 x 10 ⁻⁷)	1450
THEORETICAL ACCELERATION (rad x sec. ⁻²)	20600
BACK E.M.F. (V/Krpm)	50
MASS (Kg)	1.5
PROTECTION DEGREE	IP43
LEADS CODE	V

Codes between brackets refer to double shaft models.
Le sigle fra parentesi si riferiscono ai modelli bialbero.

TORQUE/SPEED CURVE

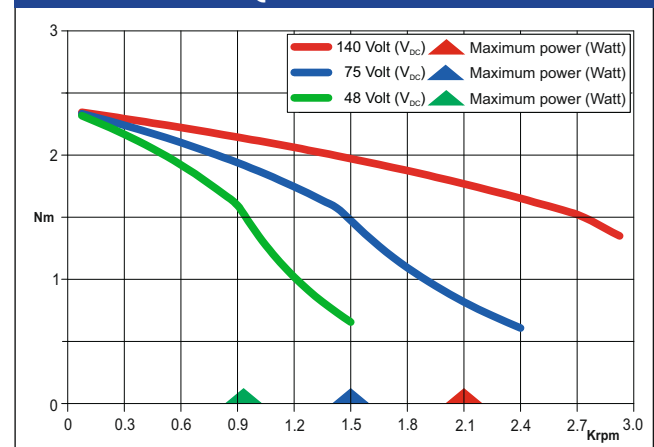

R.T.A. s.r.l. PAVIA (ITALY) SANYO DENKI CO., Ltd (JAPAN)



Suggested R.T.A. driver: NDC/A-NDC Series, HGD Series, PLUS Series.



R.T.A. s.r.l.
Via E. Mattei - Fraz- Divisa
27020 Marcignago (PV) (Italy)
T +39.0382.929.855
F +39.0382.929.150
www.rta.it

R.T.A. Deutschland GmbH
Bublitzter Strasse 34, 40599
Duesseldorf (Germany)
T +49.211.749.668.60
F +49.211.749.668.66
www.rta-deutschland.de

R.T.A. IBERICA
C/Generalitat 22, Local 1
08850 Gava - Barcelona (Spain)
T +34 936.388.805
F +34 936.334.595
www.rta-iberica.es

R.T.A. INDIA Pvt
Teerth Business Center 3rd Floor, Unit No. 7,
Block EL-15, MIDC Bhosari Pimpri-Chinchwad,
Pune 411026 (India)
Tel. +91 9422507445
www.rta-india.in