

CVM103H52xxM

DIMENSIONS (UNIT:mm)

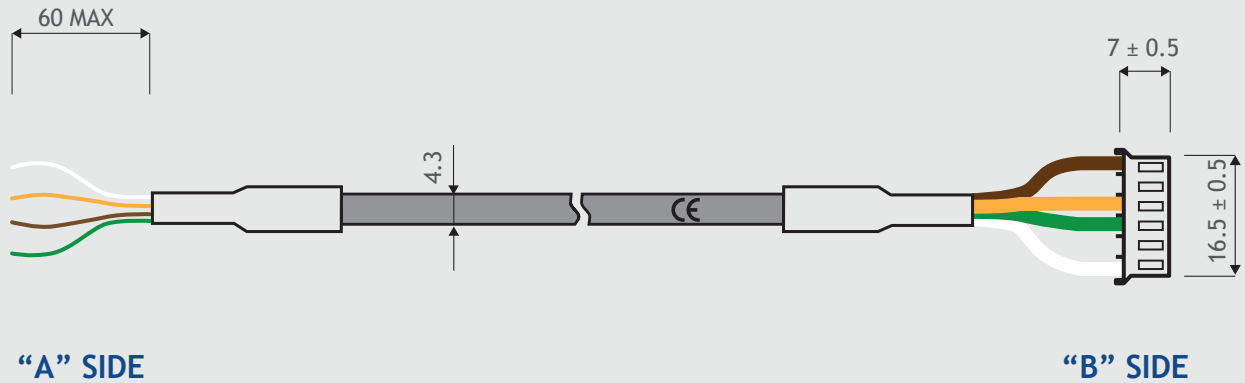

CABLE FEATURES

General info	4xAWG23
Cable diameter (mm)	4.3
Shielded	No
Flex chain	No
Curvature radius (xØ)	5
Cable speed (m/s)	/
Related Motors	H52 Series
Available lengths (m)	0.3, 2
International Standard	RoHS, CE

“A” SIDE

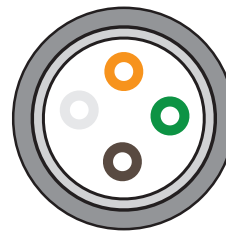

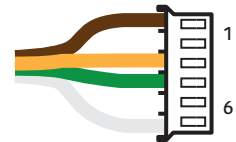

“B” SIDE



R.T.A. s.r.l. PAVIA (ITALY)

CONNECTORS FEATURES

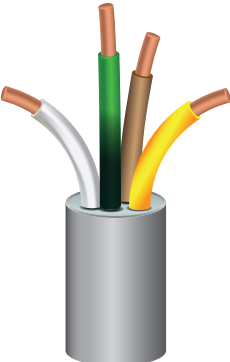
DRIVE SIDE FREE WIRES	CABLE COLORS	MOTOR SIDE JST CONNECTOR
CHANNEL A+	WHITE	1
/	NOT CONNECTED	2
CHANNEL A-	GREEN	3
CHANNEL B-	YELLOW	4
/	NOT CONNECTED	5
CHANNEL B+	BROWN	6

R.T.A. Srl
T +39 0382 929 855
www.rta.it
info@rta.it

R.T.A. Deutschland GmbH
T +49 211 74966860
www.rta-deutschland.de
info@rta-deutschland.de

R.T.A. IBERICA
T +34 936 388805
www.rta-iberica.es
info@rta-iberica.es

R.T.A. INDIA Pvt LTD
T +91 9422507445
www.rta-india.in
info@rta-india.in

CVMRH1SxxM

DIMENSIONS (UNIT:mm)

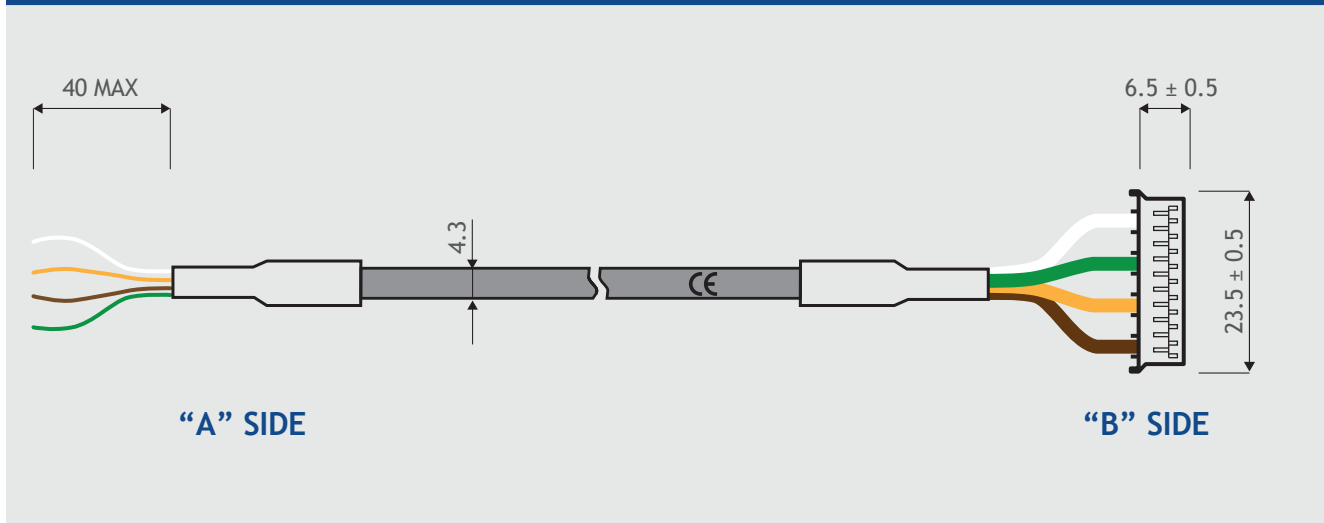

CABLE FEATURES

General info	4xAWG23
Cable diameter (mm)	4.3
Shielded	No
Flex chain	No
Curvature radius (xØ)	5
Cable speed (m/s)	/
Related Motors	RH Series
Available lengths (m)	0.3, 1, 2, 3
International Standard	RoHS, CE

"A" SIDE

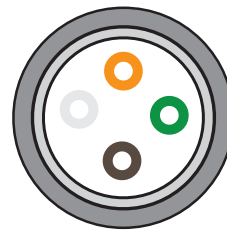

"B" SIDE

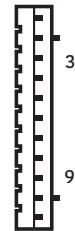

R.T.A. s.r.l. PAVIA (ITALY)

CONNECTORS FEATURES

DRIVE SIDE FREE WIRES	CABLE COLORS	MOTOR SIDE JST CONNECTOR
/	/	1
/	/	2
CHANNEL B-	BROWN	3
/	/	4
CHANNEL B+	YELLOW	5
/	/	6
CHANNEL A-	GREEN	7
/	/	8
CHANNEL A+	WHITE	9
/	/	10
/	/	11

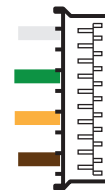
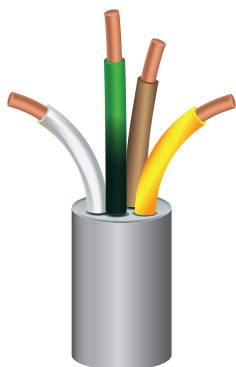

R.T.A. Srl
T +39 0382 929 855
www.rta.it
info@rta.it

R.T.A. Deutschland GmbH
T +49 211 74966860
www.rta-deutschland.de
info@rta-deutschland.de

R.T.A. IBERICA
T +34 936 388805
www.rta-iberica.es
info@rta-iberica.es

R.T.A. INDIA Pvt LTD
T +91 9422507445
www.rta-india.in
info@rta-india.in

CVMRHxxM

DIMENSIONS (UNIT:mm)

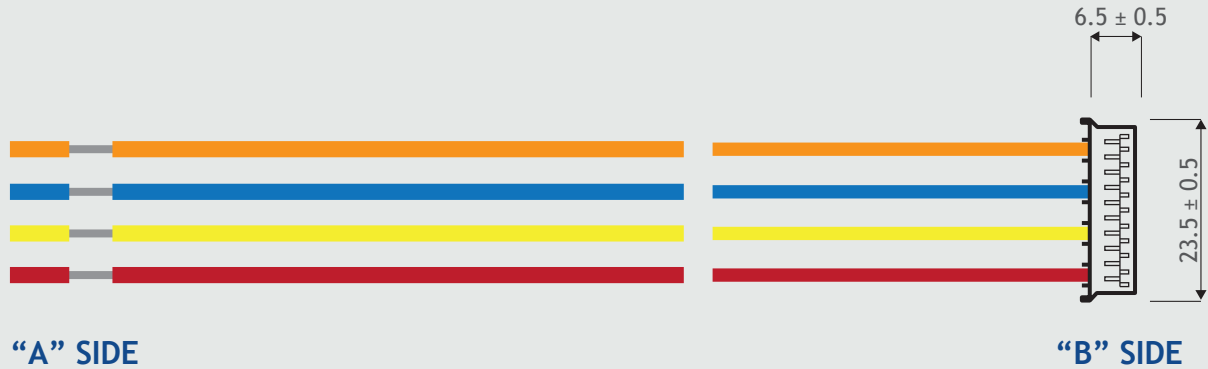

CABLE FEATURES

General info	4xAWG24
Cable diameter (mm)	/
Shielded	No
Flex chain	No
Curvature radius (xØ)	5
Cable speed (m/s)	/
Related Motors	RH Series
Available lengths (m)	0.3, 1, 2, 3
International Standard	CE, UL, CSA

"A" SIDE



"B" SIDE

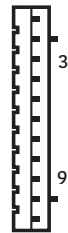

CONNECTORS FEATURES

DRIVE SIDE FREE WIRES	CABLE COLORS	MOTOR SIDE JST CONNECTOR
/	/	1
/	/	2
CHANNEL B-	RED	3
/	/	4
CHANNEL B+	YELLOW	5
/	/	6
CHANNEL A-	BLUE	7
/	/	8
CHANNEL A+	ORANGE	9
/	/	10
/	/	11

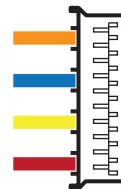
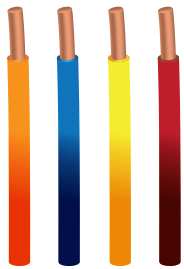

R.T.A. Srl
T +39 0382 929 855
www.rta.it
info@rta.it

R.T.A. Deutschland GmbH
T +49 211 74966860
www.rta-deutschland.de
info@rta-deutschland.de

R.T.A. IBERICA
T +34 936 388805
www.rta-iberica.es
info@rta-iberica.es

R.T.A. INDIA Pvt LTD
T +91 9422507445
www.rta-india.in
info@rta-india.in

CVMRM(90)PMxxM

DIMENSIONS (UNIT:mm)

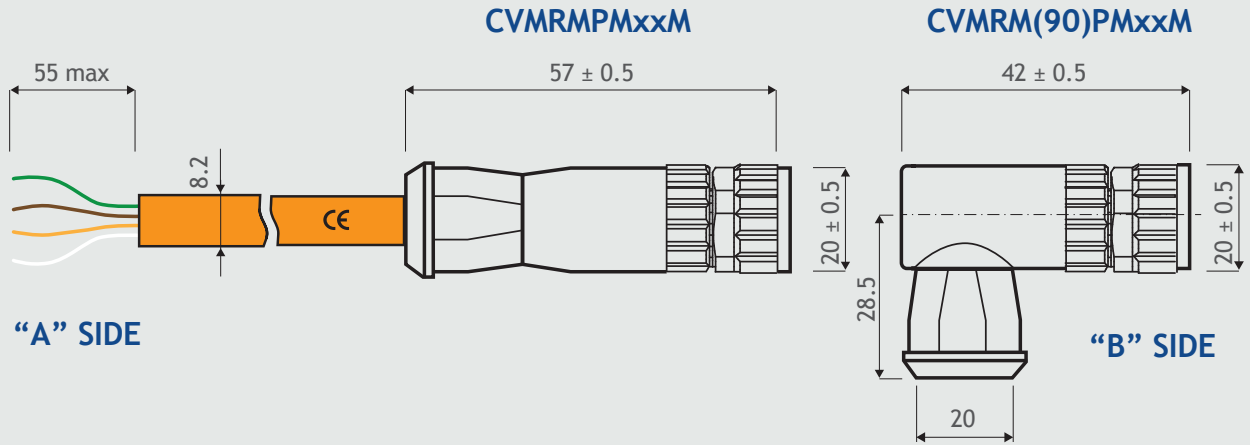

CABLE FEATURES

General info	(4xAWG18)
Cable diameter (mm)	8.2
Shielded	Yes
Flex chain	Yes
Curvature radius (xØ)	8
Cable speed (m/s)	8
Related Motors	RM Series
Available lengths (m)	1, 3, 5
International Standard	CSA, UL, RoHS,CE

"A" SIDE

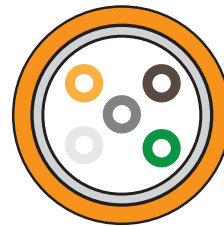

"B" SIDE

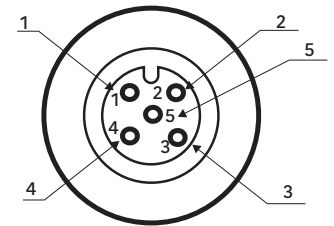

CONNECTORS FEATURES

DRIVE SIDE	CABLE	MOTOR SIDE
FREE WIRES	PF - PM - C068 (ORANGE)	STREIGHT - MO631 (43-00092)
A PHASE	YELLOW AWG18	90° - MO642 (43-00096)
A- PHASE	WHITE AWG18	1
B PHASE	GREEN AWG18	2
B- PHASE	BROWN AWG18	3
ROLLED	SHIELD	4
		/

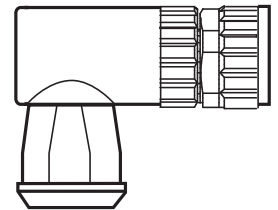
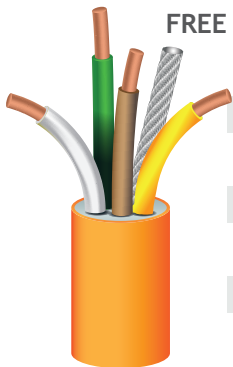

R.T.A. Srl
T +39 0382 929 855
www.rta.it
info@rta.it

R.T.A. Deutschland GmbH
T +49 211 74966860
www.rta-deutschland.de
info@rta-deutschland.de

R.T.A. IBERICA
T +34 936 388805
www.rta-iberica.es
info@rta-iberica.es

R.T.A. INDIA Pvt LTD
T +91 9422507445
www.rta-india.in
info@rta-india.in

CVERM(90)PMxxM

DIMENSIONS (UNIT:mm)

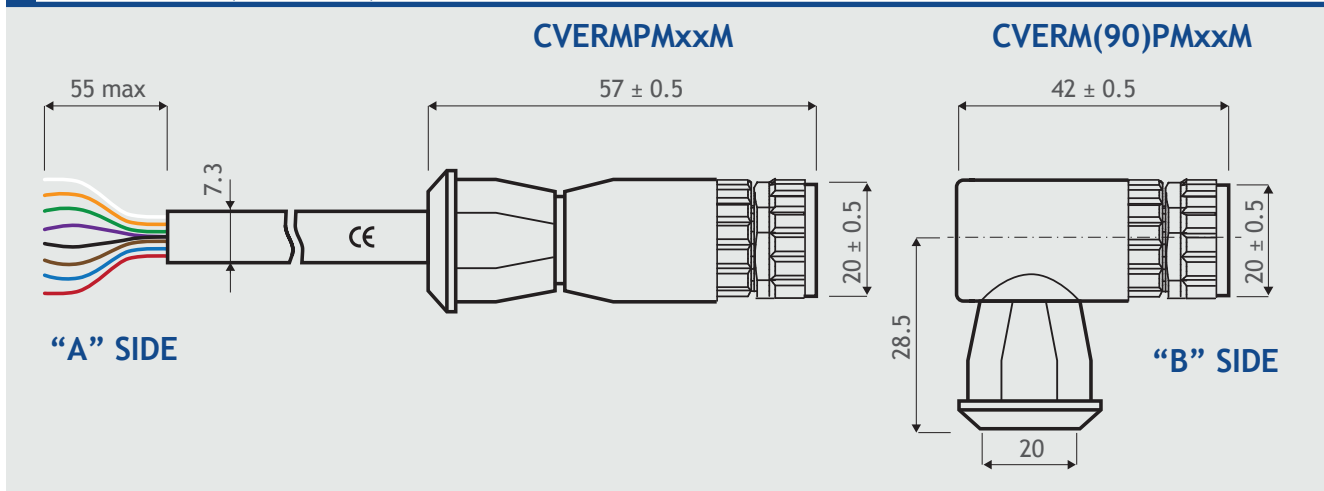

CABLE FEATURES

General info (3x2AWG26+2xAWG22)

Cable diameter (mm) 7.3

Shielded Yes

Flex chain Yes

Curvature radius (xØ) 7.5

Cable speed (m/s) 3

Related Motors RM Series

Available lengths (m) 1, 3, 5, 10

International Standard CE, RoHS, UL

Pairs Purple-Green, White-Orange, Blue-Brown, Black-Red

"A" SIDE

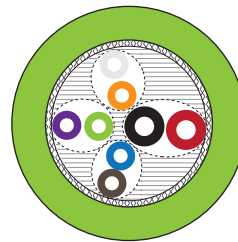

"B" SIDE

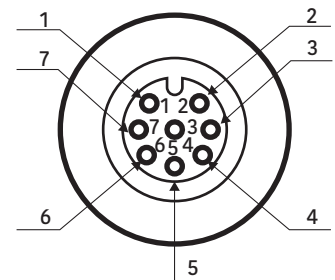

CONNECTORS FEATURES

DRIVE SIDE

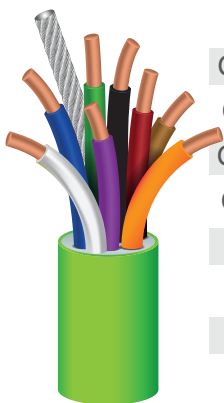

DRIVE SIDE	CABLE	
CHANNEL A+	BLUE AWG26	1
CHANNEL A-	BROWN AWG26	2
CHANNEL B+	GREEN AWG26	3
CHANNEL B-	PURPLE AWG26	4
GROUND	BLACK AWG22	5
INDEX -	WHITE AWG26	6
INDEX +	ORANGE AWG26	7
+DC (5V)	RED AWG22	8
ROLLED	SHIELD	/

CABLE

PF - PM - C048 (GREEN)

ENCODER SIDE

DRITTO - MO630 (43-00130)

90° - MO641 (43-00131)

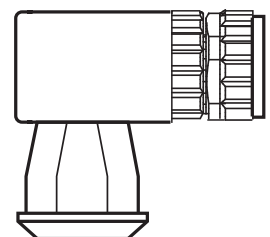
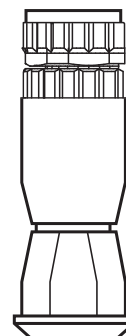

- 1
- 2
- 3
- 4
- 5
- 6
- 7
- 8
- /



R.T.A. Srl
T +39 0382 929 855
www.rta.it
info@rta.it

R.T.A. Deutschland GmbH
T +49 211 74966860
www.rta-deutschland.de
info@rta-deutschland.de

R.T.A. IBERICA
T +34 936 388805
www.rta-iberica.es
info@rta-iberica.es

R.T.A. INDIA Pvt LTD
T +91 9422507445
www.rta-india.in
info@rta-india.in

CVM(90)SPxxM

DIMENSIONS (UNIT:mm)

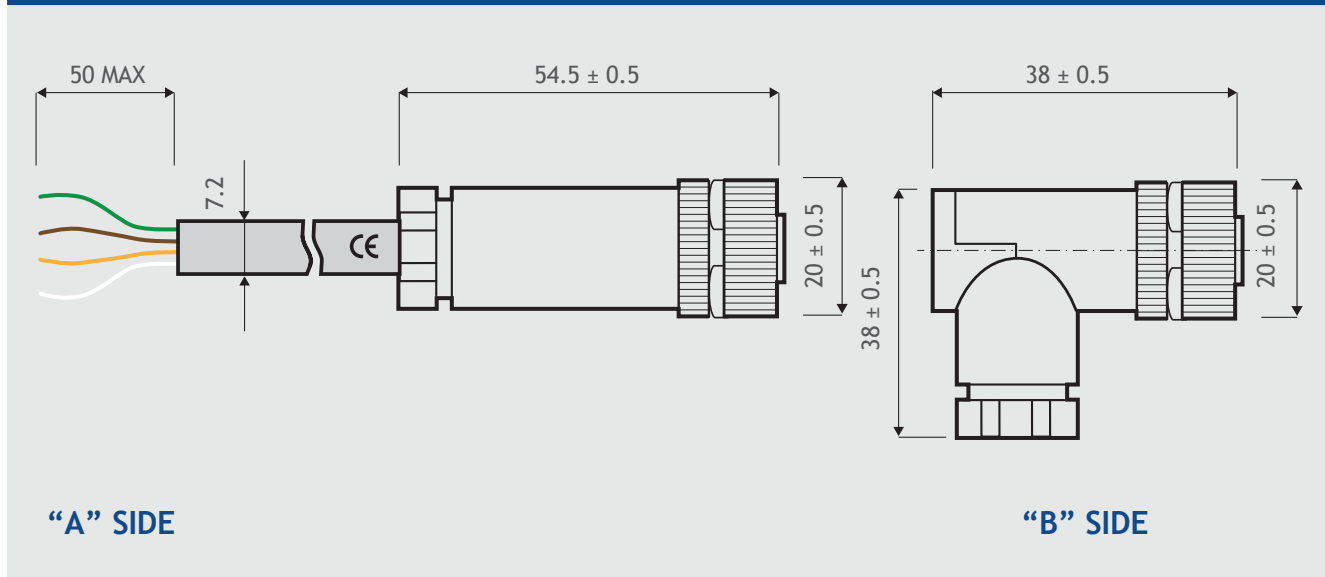

CABLE FEATURES

General info	(4XAWG18)
Cable diameter (mm)	7.2
Shielded	Yes
Flex chain	No
Curvature radius (xØ)	6
Cable speed (m/s)	/
Related Motors	SP Series
Available lengths (m)	1, 3
International Standard	CE, RoHS

"A" SIDE

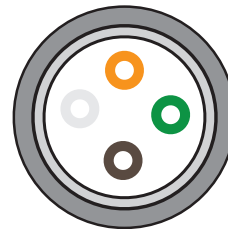

"B" SIDE

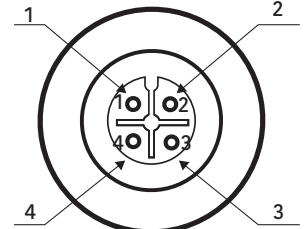

CONNECTORS FEATURES

DRIVE SIDE FREE WIRES

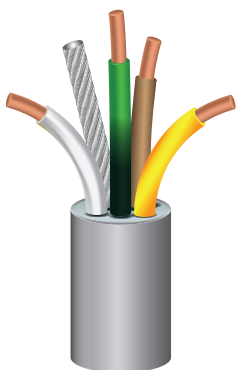

CHANNEL	CABLE	
CHANNEL A+	YELLOW	1
CHANNEL A-	WHITE	2
CHANNEL B+	GREEN	3
CHANNEL B-	BROWN	4
ROLLED	SHIELD	/

CABLE

MOTOR SIDE

STRAIGHT CONNECTOR



90° CONNECTOR

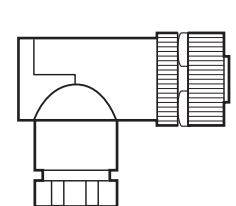

1
2
3
4
/



R.T.A. Srl
T +39 0382 929 855
www.rta.it
info@rta.it

R.T.A. Deutschland GmbH
T +49 211 74966860
www.rta-deutschland.de
info@rta-deutschland.de

R.T.A. IBERICA
T +34 936 388805
www.rta-iberica.es
info@rta-iberica.es

R.T.A. INDIA Pvt LTD
T +91 9422507445
www.rta-india.in
info@rta-india.in

CVM77xxx

DIMENSIONS (UNIT:mm)

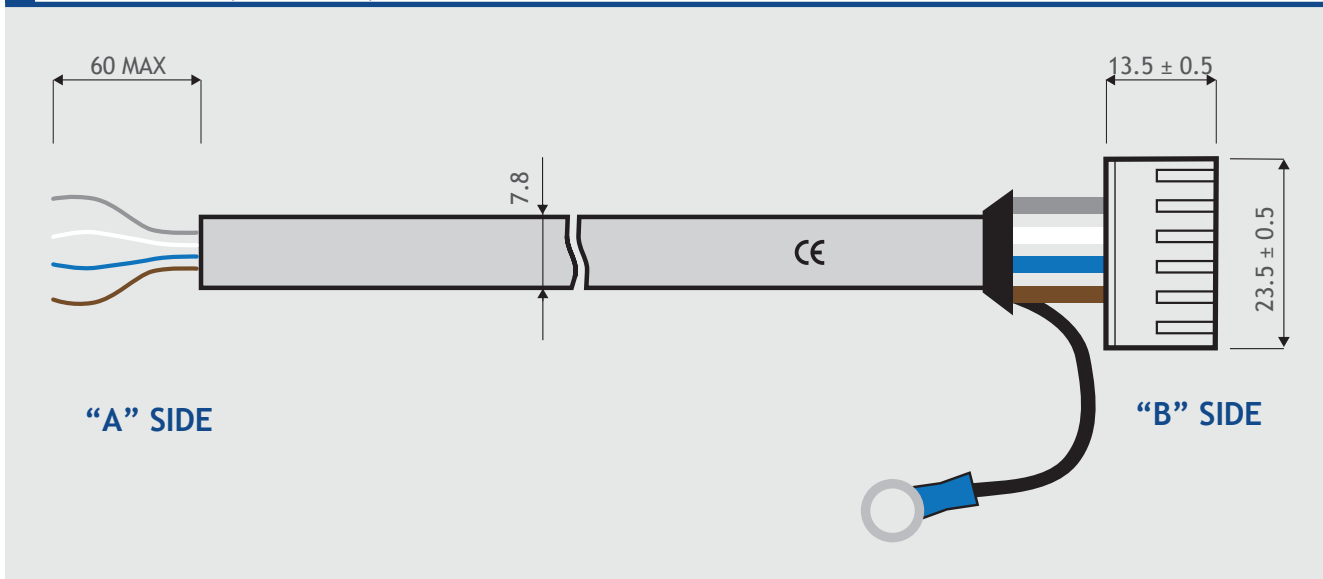

CABLE FEATURES

General info	(4xAWG17)
Cable diameter (mm)	7.8
Shielded	Yes
Flex chain	No
Curvature radius (xØ)	/
Cable speed (m/s)	/
Related Motors	H7822 Series
Available lengths (m)	1, 3
International Standard	CE, RoHS

"A" SIDE

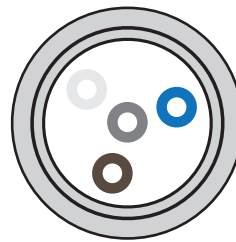

"B" SIDE

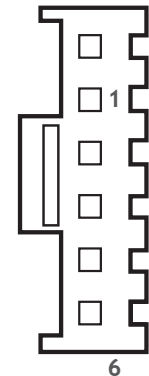

CONNECTORS FEATURES

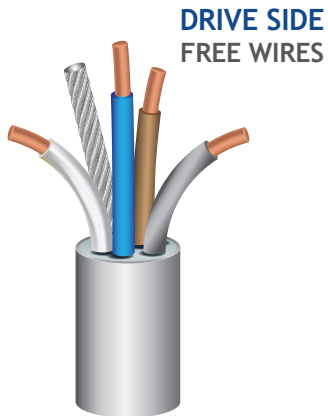

DRIVE SIDE
FREE WIRES

	CABLE JST CONNECTOR	
/	NOT CONNECTED	1
CHANNEL A+	GREY	2
CHANNEL A-	WHITE	3
CHANNEL B+	BLUE	4
CHANNEL B-	BROWN	5
/	NOT CONNECTED	6
ROLLED	SHIELD	/

MOTOR SIDE

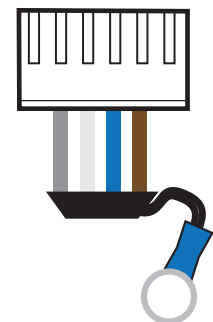

R.T.A. Srl
T +39 0382 929 855
www.rta.it
info@rta.it

R.T.A. Deutschland GmbH
T +49 211 74966860
www.rta-deutschland.de
info@rta-deutschland.de

R.T.A. IBERICA
T +34 936 388805
www.rta-iberica.es
info@rta-iberica.es

R.T.A. INDIA Pvt LTD
T +91 9422507445
www.rta-india.in
info@rta-india.in

CVM78xxx

DIMENSIONS (UNIT:mm)

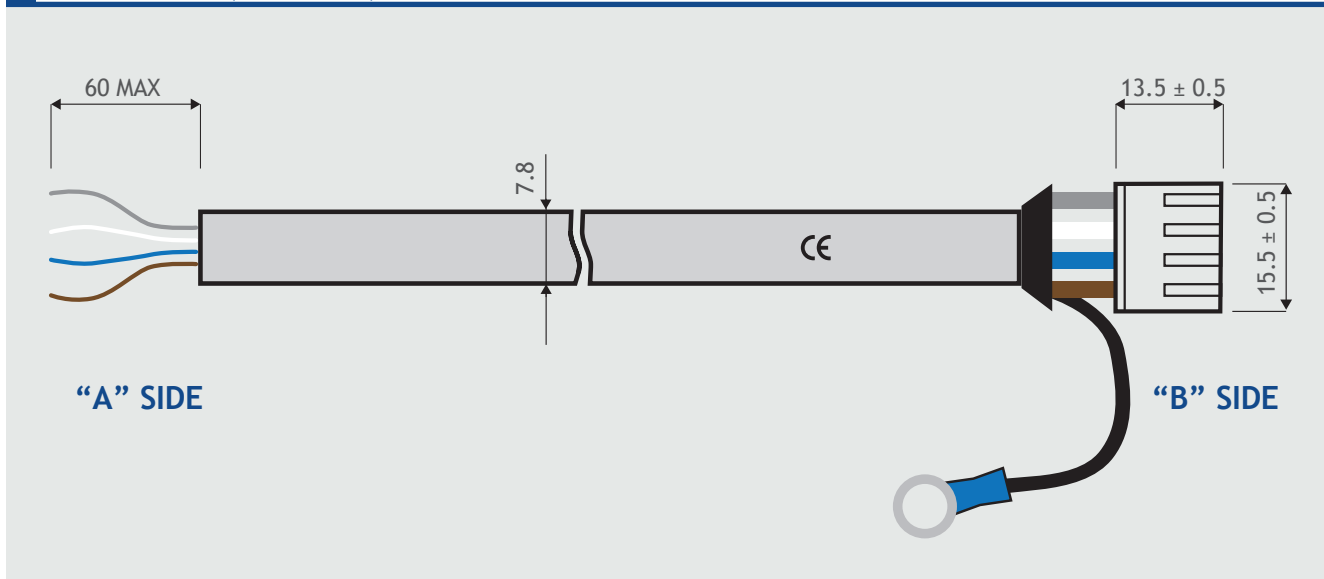

CABLE FEATURES

General info	(4xAWG17)
Cable diameter (mm)	7.8
Shielded	Yes
Flex chain	No
Curvature radius (xØ)	/
Cable speed (m/s)	/
Related Motors	H7823 Series
Available lengths (m)	1, 3
International Standard	CE, RoHS

"A" SIDE

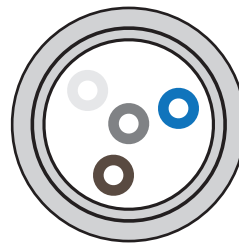

"B" SIDE

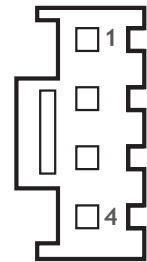

CONNECTORS FEATURES

DRIVE SIDE FREE WIRES

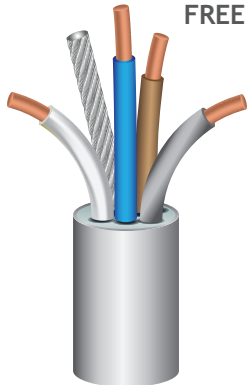

DRIVE SIDE FREE WIRES	CABLE	
CHANNEL A+	GREY	1
CHANNEL A-	WHITE	2
CHANNEL B+	BLUE	3
CHANNEL B-	BROWN	4
ROLLED	SHIELD	/

CABLE

MOTOR SIDE JST CONNECTOR

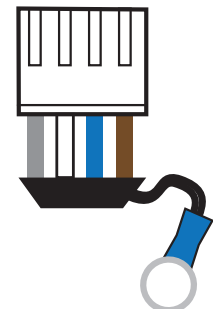

R.T.A. Srl
T +39 0382 929 855
www.rta.it
info@rta.it

R.T.A. Deutschland GmbH
T +49 211 74966860
www.rta-deutschland.de
info@rta-deutschland.de

R.T.A. IBERICA
T +34 936 388805
www.rta-iberica.es
info@rta-iberica.es

R.T.A. INDIA Pvt LTD
T +91 9422507445
www.rta-india.in
info@rta-india.in

CVEPAZDOxxM

DIMENSIONS (UNIT:mm)

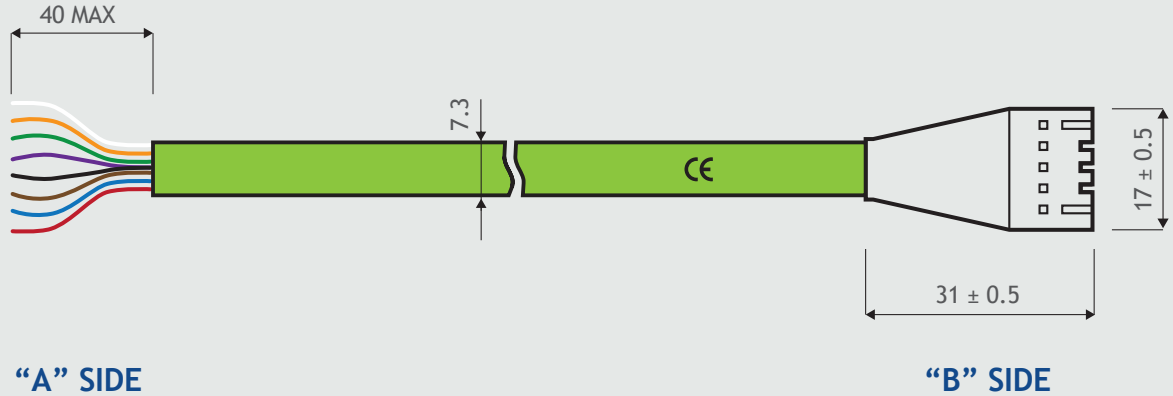

CABLE FEATURES

General info	(3x2AWG26+2AWG22)
Cable diameter (mm)	7.3
Shielded	Yes
Flex chain	Yes
Curvature radius (xØ)	7.5
Cable speed (m/s)	3
Related Motors	EM Series (Index version)
Available lengths (m)	0.3, 2, 3, 5
International Standard	cUL, CE, RoHS
Pairs	Purple-Green, Blue-Brown, White-Orange, Black-Red

"A" SIDE



"B" SIDE

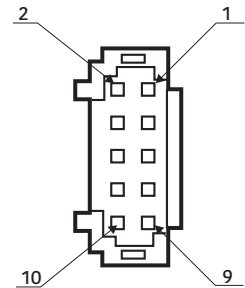

CONNECTORS FEATURES

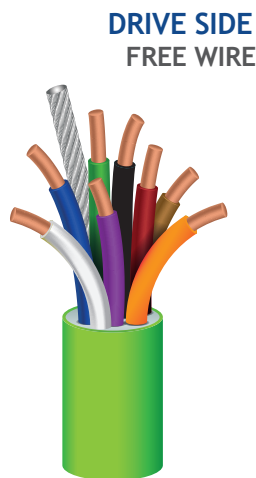

DRIVE SIDE FREE WIRE

CABLE

ENCODER SIDE 14-60-0058

/	Not Connected	1
+ DC (5V)	RED AWG22	2
GROUND	BLACK AWG22	3
/	Not Connected	4
CHANNEL A-	PURPLE AWG26	5
CHANNEL A+	GREEN AWG26	6
CHANNEL B-	BROWN AWG26	7
CHANNEL B+	BLUE AWG26	8
INDEX-	WHITE AWG26	9
INDEX+	ORANGE AWG26	10

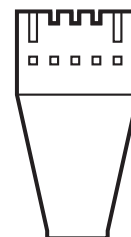

R.T.A. Srl
T +39 0382 929 855
www.rta.it
info@rta.it

R.T.A. Deutschland GmbH
T +49 211 74966860
www.rta-deutschland.de
info@rta-deutschland.de

R.T.A. IBERICA
T +34 936 388805
www.rta-iberica.es
info@rta-iberica.es

R.T.A. INDIA Pvt LTD
T +91 9422507445
www.rta-india.in
info@rta-india.in

CVEPA0D0xxM

DIMENSIONS (UNIT:mm)

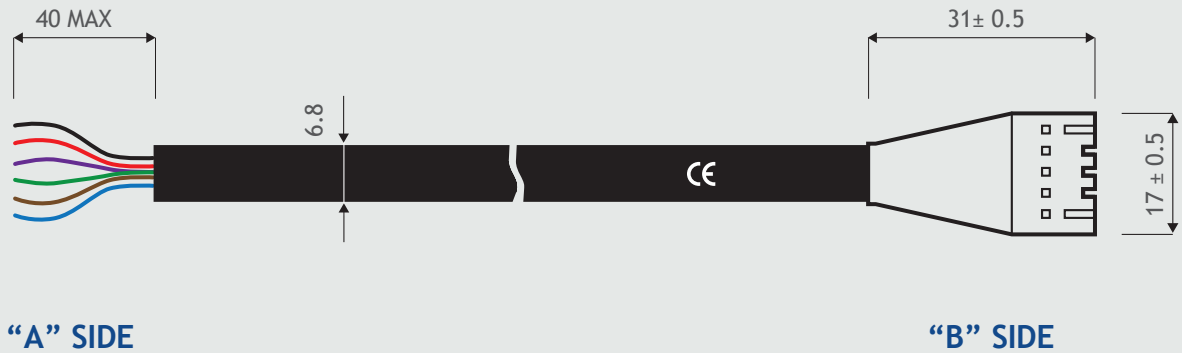

CABLE FEATURES

General info	(3x2AWG26)
Cable diameter (mm)	6.8
Shielded	Yes
Flex chain	No
Curvature radius (xØ)	7.5
Cable speed (m/s)	/
Related Motors	EM Series
Available lengths (m)	0.3, 2, 3
International Standard	CE, RoHS
Pairs	Black-Red, Green-Purple, Blue-Brown

"A" SIDE



"B" SIDE

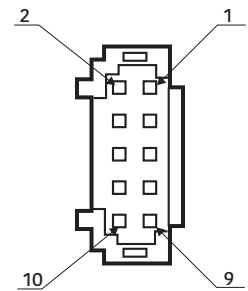

CONNECTORS FEATURES

DRIVE SIDE FREE WIRE	CABLE	ENCODER SIDE 14-60-0058
/	Not Connected	1
+ DC (5V)	RED AWG26	2
GROUND	BLACK AWG26	3
/	Not Connected	4
CHANNEL A-	PURPLE AWG26	5
CHANNEL A+	GREEN AWG26	6
CHANNEL B-	BROWN AWG26	7
CHANNEL B+	BLUE AWG26	8
/	Not Connected	9
/	Not Connected	10

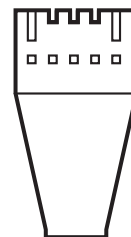

R.T.A. Srl
T +39 0382 929 855
www.rta.it
info@rta.it

R.T.A. Deutschland GmbH
T +49 211 74966860
www.rta-deutschland.de
info@rta-deutschland.de

R.T.A. IBERICA
T +34 936 388805
www.rta-iberica.es
info@rta-iberica.es

R.T.A. INDIA Pvt LTD
T +91 9422507445
www.rta-india.in
info@rta-india.in

CVFSPMxxM

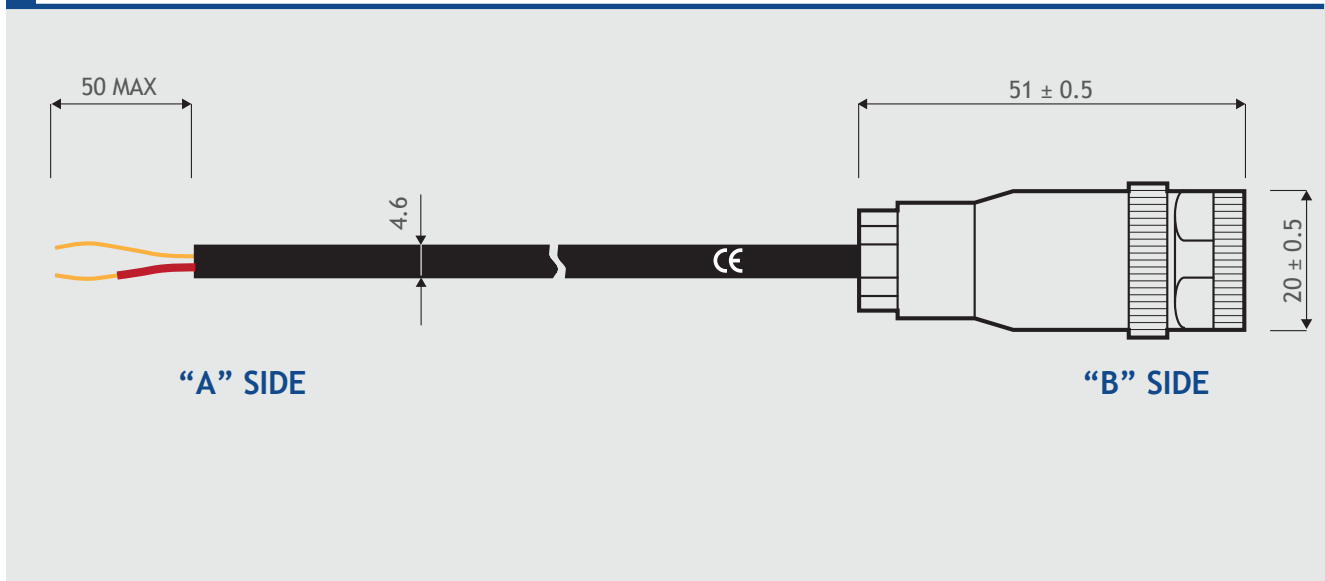

CABLE FEATURES

General info	(2xAWG20)
Cable diameter (mm)	4.6
Shielded	Yes
Flex chain	Yes
Curvature radius (xØ)	7.5
Cable speed (m/s)	3.3
Available lengths (m)	1, 3
International Standard	RoHS

"A" SIDE

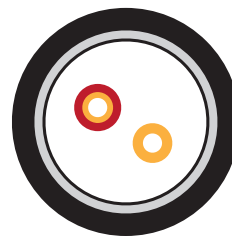

"B" SIDE

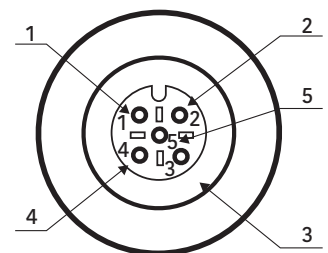

CONNECTORS FEATURES

SUPPLY STEPPER DRIVE

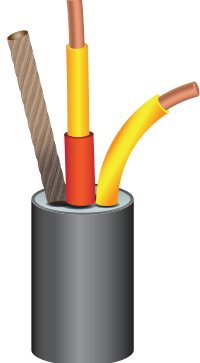

+24 VDC	YELLOW-RED (WITH HEAT SHRINK TUBING)	1
0 V	YELLOW	2
/	/	3
/	/	4
	SHIELD	/

CABLE FREE WIRES

MOTOR SIDE STRAIGHT CONNECTOR

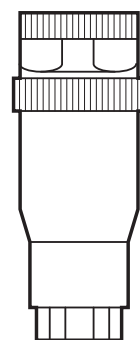

R.T.A. Srl
T +39 0382 929 855
www.rta.it
info@rta.it

R.T.A. Deutschland GmbH
T +49 211 74966860
www.rta-deutschland.de
info@rta-deutschland.de

R.T.A. IBERICA
T +34 936 388805
www.rta-iberica.es
info@rta-iberica.es

R.T.A. INDIA Pvt LTD
T +91 9422507445
www.rta-india.in
info@rta-india.in

CVFS90PMxxM

DIMENSIONS (UNIT:mm)

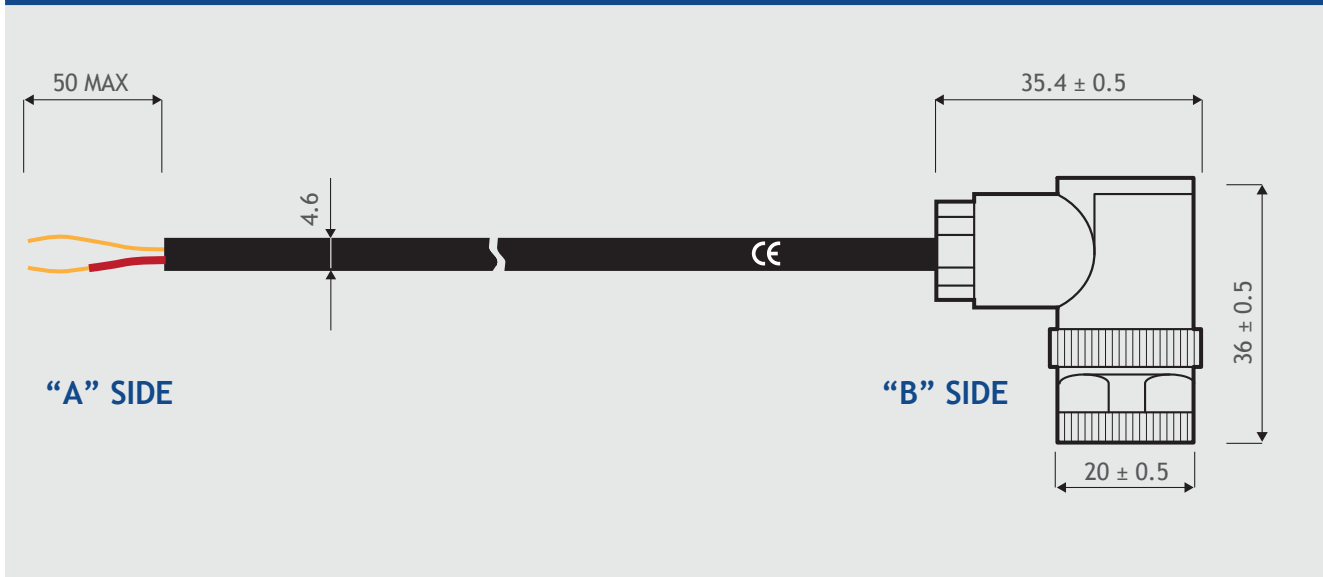

CABLE FEATURES

General info	(2xAWG20)
Cable diameter (mm)	4.6
Shielded	Yes
Flex chain	Yes
Curvature radius (xØ)	7.5
Cable speed (m/s)	3.3
Available lengths (m)	1, 3
International Standard	RoHS

"A" SIDE

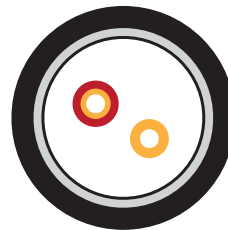

"B" SIDE

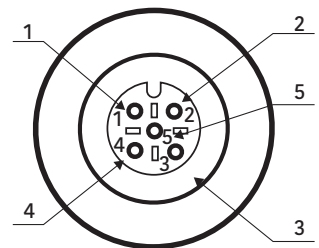

R.T.A. s.r.l. PAVIA (ITALY)

CONNECTORS FEATURES

SUPPLY STEPPER DRIVE

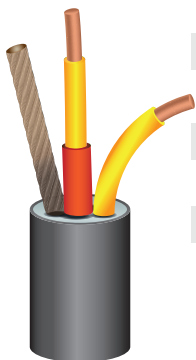

SUPPLY STEPPER DRIVE	CABLE FREE WIRES	MOTOR SIDE STRAIGHT CONNECTOR
+24 VDC	YELLOW-RED (WITH HEAT SHRINK TUBING)	1
/	/	2
0 V	YELLOW	3
/	/	4
	SHIELD	/

MOTOR SIDE STRAIGHT CONNECTOR

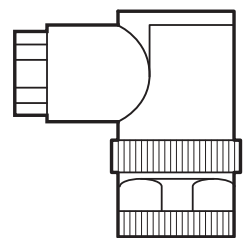

R.T.A. Srl
T +39 0382 929 855
www.rta.it
info@rta.it

R.T.A. Deutschland GmbH
T +49 211 74966860
www.rta-deutschland.de
info@rta-deutschland.de

R.T.A. IBERICA
T +34 936 388805
www.rta-iberica.es
info@rta-iberica.es

R.T.A. INDIA Pvt LTD
T +91 9422507445
www.rta-india.in
info@rta-india.in

CVFRPMxxM

DIMENSIONS (UNIT:mm)

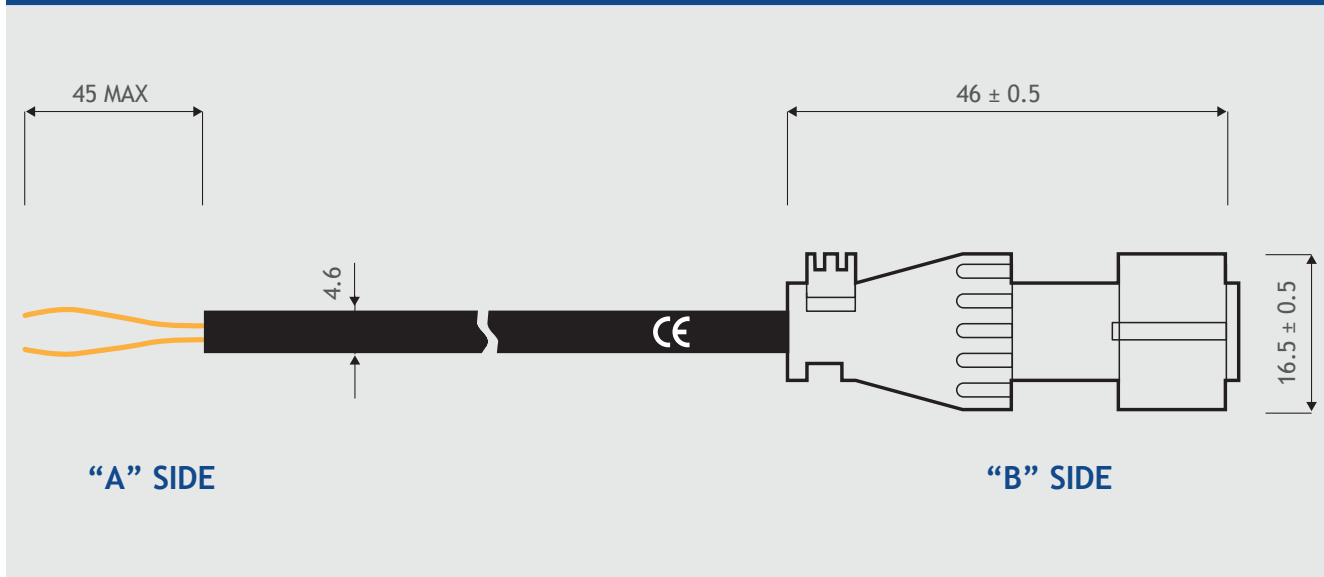

CABLE FEATURES

General info	(2xAWG20)
Cable diameter (mm)	4.6
Shielded	Yes
Flex chain	Yes
Curvature radius (xØ)	7.5
Cable speed (m/s)	3.3
Available lengths (m)	1, 2, 3.5, 5, 10
International Standard	RoHS, CE

"A" SIDE

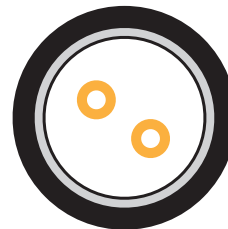

"B" SIDE

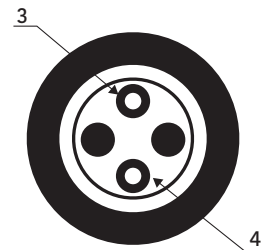

CONNECTORS FEATURES

POWER SUPPLY

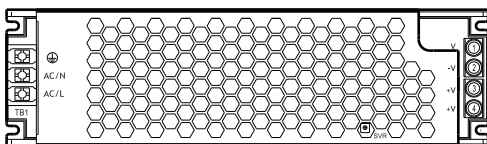

CABLE

WIRES

DISCONNECT	1
DISCONNECT	2
YELLOW	3
YELLOW	4
SHIELD	/

MOTOR SIDE

AMP - 1445390-1 CONNECTOR

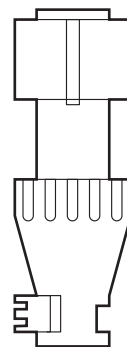

R.T.A. Srl
T +39 0382 929 855
www.rta.it
info@rta.it

R.T.A. Deutschland GmbH
T +49 211 74966860
www.rta-deutschland.de
info@rta-deutschland.de

R.T.A. IBERICA
T +34 936 388805
www.rta-iberica.es
info@rta-iberica.es

R.T.A. INDIA Pvt LTD
T +91 9422507445
www.rta-india.in
info@rta-india.in

CVMBRARPMMxxM

DIMENSIONS (UNIT:mm)

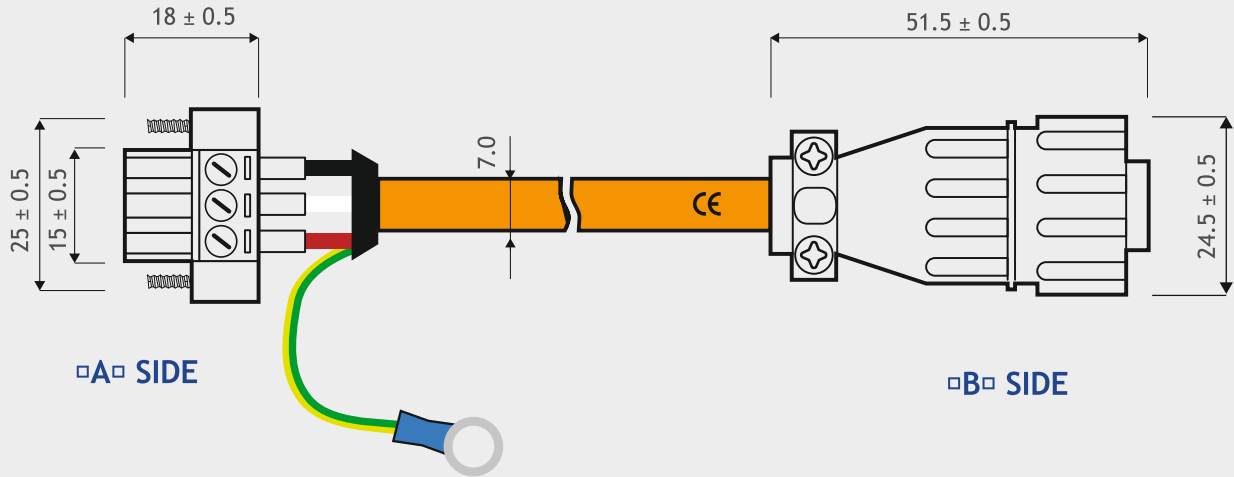

CABLE FEATURES

General info	(3xAWG19)
Cable diameter (mm)	7.0
Shielded	Yes
Flex chain	Yes
Curvature radius (xØ)	56 mm
Cable speed (m/s)	8
Related Motors	R2 Series
Available lengths (m)	1, 2, 3.5, 5, 10
International Standard	cUL, RoHS, CSA

A SIDE

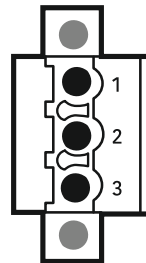

B SIDE

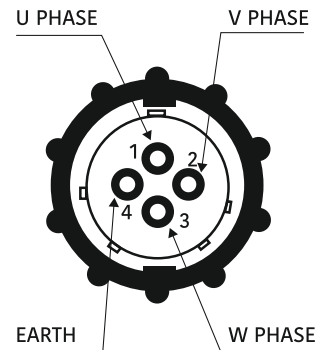

CONNECTORS FEATURES

DRIVE SIDE
PHOENIX CONTACT MSTBT2.5/3-STF-5.08

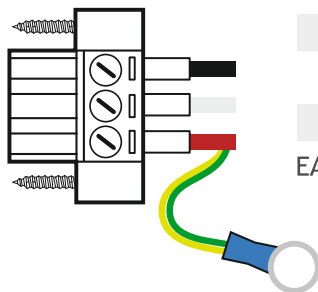

1 [U]	RED AWG19	1
2 [V]	WHITE AWG19	2
3 [W]	BLACK AWG19	3
EARTH CABLE	SHIELD	4

CABLE
WIRE

MOTOR SIDE
AMP - TYCO 182647-1

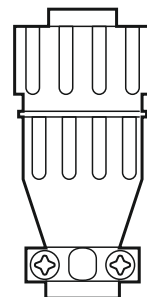

R.T.A. Srl
T +39 0382 929 855
www.rta.it
info@rta.it

R.T.A. Deutschland GmbH
T +49 211 74966860
www.rta-deutschland.de
info@rta-deutschland.de

R.T.A. IBERICA
T +34 936 388805
www.rta-iberica.es
info@rta-iberica.es

R.T.A. INDIA Pvt LTD
T +91 9422507445
www.rta-india.in
info@rta-india.in

CVMBRARxxM

DIMENSIONS (UNIT:mm)

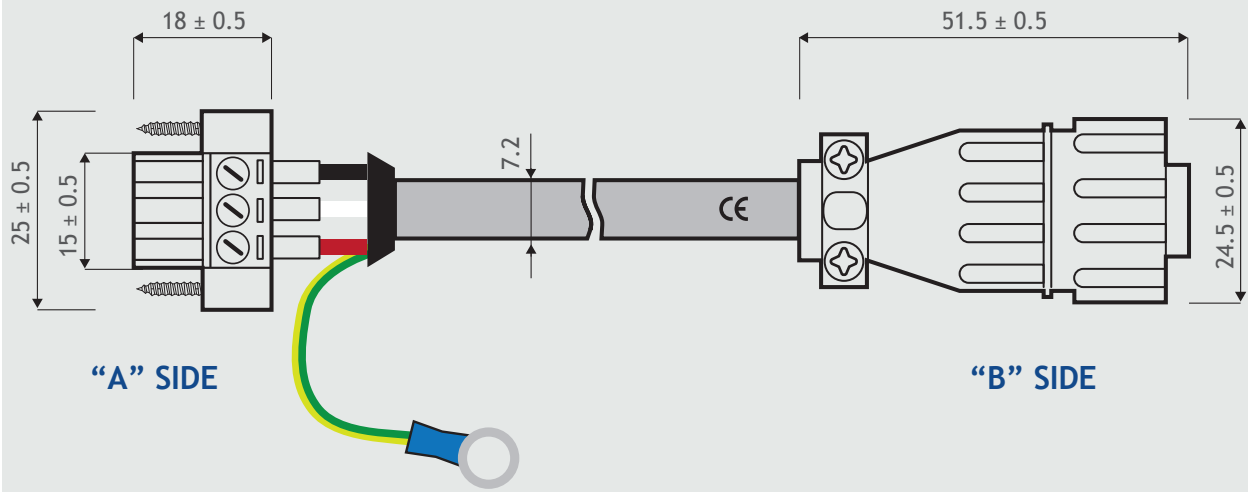

CABLE FEATURES

General info	(3xAWG17)
Cable diameter (mm)	7.2
Shielded	Yes
Flex chain	No
Curvature radius (xØ)	6
Cable speed (m/s)	/
Related Motors	R2 Series
Available lengths (m)	1, 2, 3.3, 5, 10
International Standard	RoHS

"A" SIDE

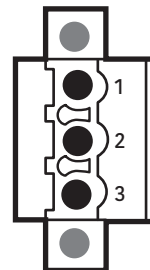

"B" SIDE

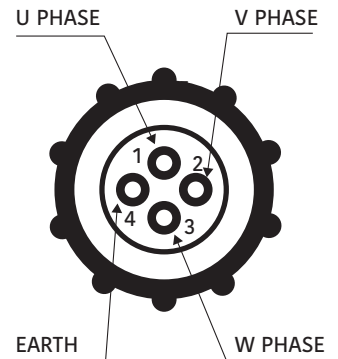

CONNECTORS FEATURES

DRIVE SIDE

PHOENIX CONTACT MSTBT2.5/3-STF5.08

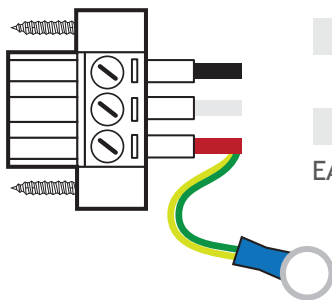

1 [U]	RED AWG17	1
2 [V]	WHITE AWG17	2
3 [W]	BLACK AWG17	3
EARTH CABLE	SHIELD	4

CABLE

WIRE

MOTOR SIDE

AMP-TYCO 182647-1

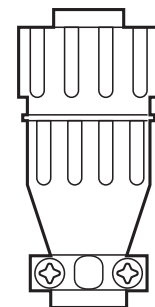

R.T.A. Srl
T +39 0382 929 855
www.rta.it
info@rta.it

R.T.A. Deutschland GmbH
T +49 211 74966860
www.rta-deutschland.de
info@rta-deutschland.de

R.T.A. IBERICA
T +34 936 388805
www.rta-iberica.es
info@rta-iberica.es

R.T.A. INDIA Pvt LTD
T +91 9422507445
www.rta-india.in
info@rta-india.in

CVMBR1ARPM90xxM

DIMENSIONS (UNIT:mm)

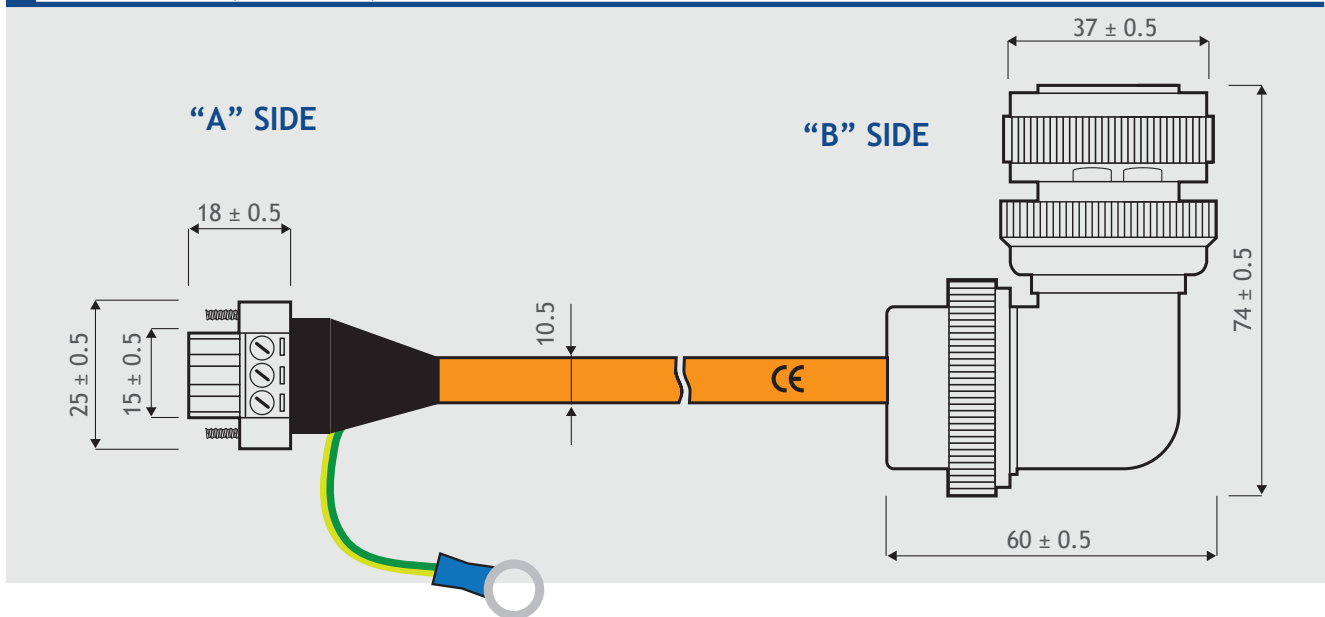

CABLE FEATURES

General info	(3xAWG13)
Cable diameter (mm)	10.5
Shielded	Yes
Flex chain	Yes
Curvature radius (xØ)	10
Cable speed (m/s)	3.3
Available lengths (m)	1, 2, 3, 5, 10
International Standard	RoHS, CE, UL

"A" SIDE

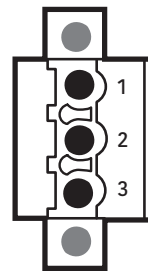

"B" SIDE

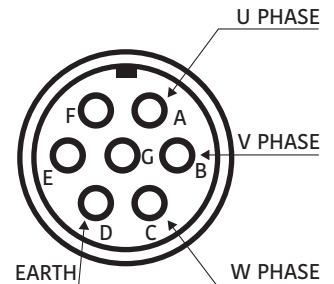

CONNECTORS FEATURES

DRIVE SIDE	CABLE	MOTOR SIDE
CONNECTOR PHOENIX MSTBT2.5/3-STF-5.08	WIRE	CONNECTOR EUMAX XMS3108F20-15S
1 [U]	RED	A
2 [V]	WHITE	B
3 [W]	BLACK	C
EARTH CABLE	SHIELD	D



R.T.A. Srl
T +39 0382 929 855
www.rta.it
info@rta.it

R.T.A. Deutschland GmbH
T +49 211 74966860
www.rta-deutschland.de
info@rta-deutschland.de

R.T.A. IBERICA
T +34 936 388805
www.rta-iberica.es
info@rta-iberica.es

R.T.A. INDIA Pvt LTD
T +91 9422507445
www.rta-india.in
info@rta-india.in

CVMBR1AR90xxM

DIMENSIONS (UNIT:mm)

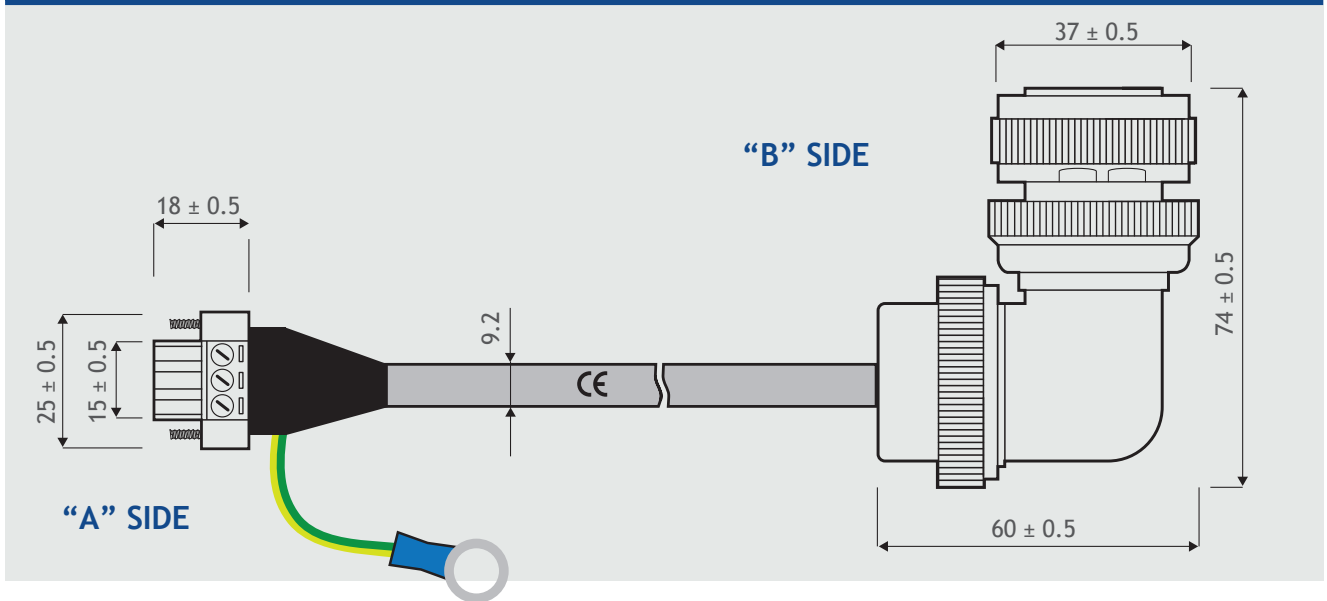

CABLE FEATURES

General info	(3xAWG13)
Cable diameter (mm)	9.2
Shielded	Yes
Flex chain	No
Curvature radius (xØ)	/
Cable speed (m/s)	/
Available lengths (m)	1, 2, 3, 5, 10
International Standard	RoHS, CE

"A" SIDE

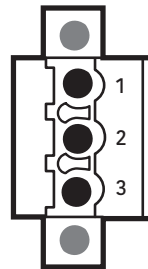

"B" SIDE

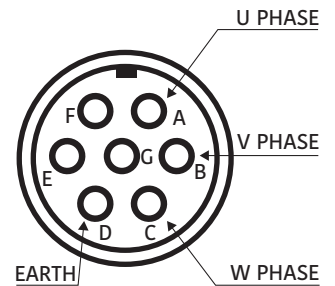

R.T.A. s.r.l. PAVIA (ITALY)

CONNECTORS FEATURES

DRIVE SIDE	CABLE	MOTOR SIDE
PHOENIX CONTACT MSTBT2.5/3-STF-5.08	WIRE	CONNECTOR 3108F-20-15S
1 [U]	RED	A
2 [V]	WHITE	B
3 [W]	BLACK	C
EARTH CABLE	SHIELD	D



R.T.A. Srl
T +39 0382 929 855
www.rta.it
info@rta.it

R.T.A. Deutschland GmbH
T +49 211 74966860
www.rta-deutschland.de
info@rta-deutschland.de

R.T.A. IBERICA
T +34 936 388805
www.rta-iberica.es
info@rta-iberica.es

R.T.A. INDIA Pvt LTD
T +91 9422507445
www.rta-india.in
info@rta-india.in

CVMBAR90QHPMxxM

DIMENSIONS (UNIT:mm)

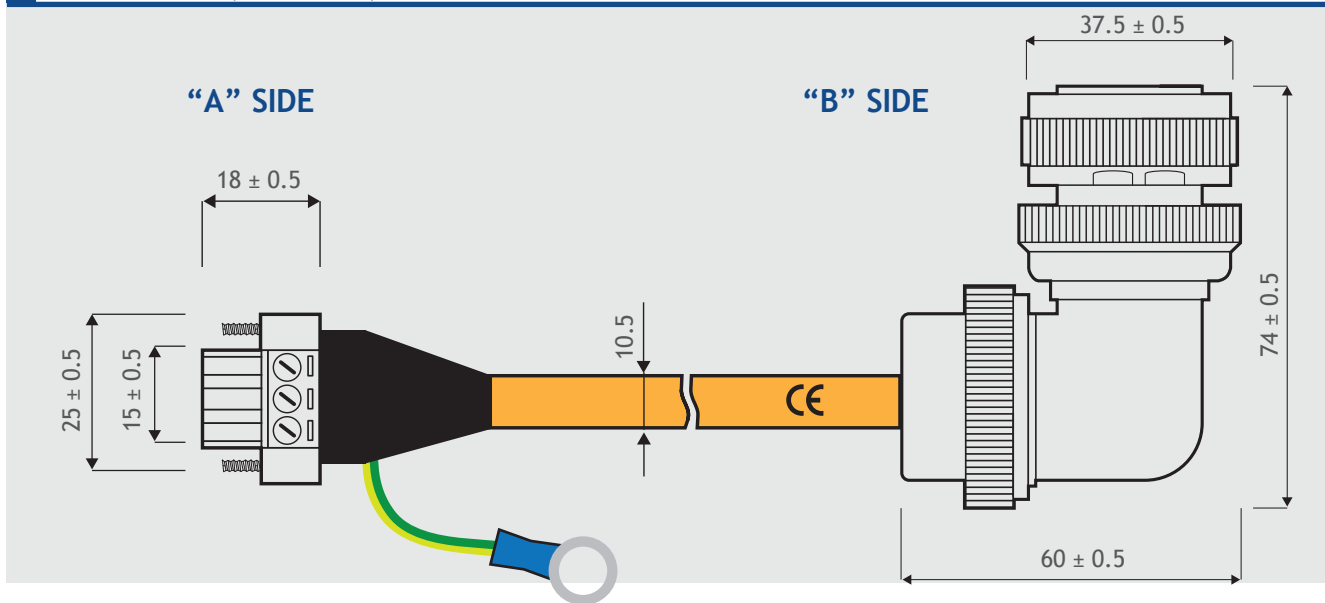

CABLE FEATURES

General info	(3xAWG13)
Cable diameter (mm)	10.5
Shielded	Yes
Flex chain	Yes
Curvature radius (xØ)	10
Cable speed (m/s)	3.3
Available lengths (m)	1, 2, 3.5, 5, 10
International Standard	RoHS, CE

"A" SIDE

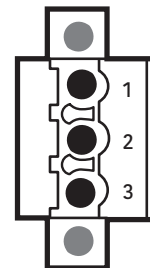

"B" SIDE

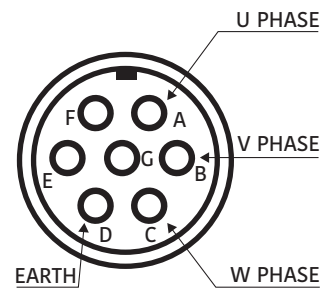

CONNECTORS FEATURES

DRIVE SIDE

CONNECTOR PHOENIX MSTBT2.5/3-STF-5.08

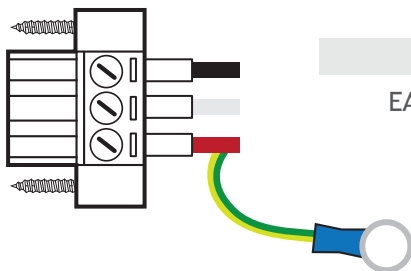

1 [U]
2 [V]
3 [W]
EARTH CABLE

CABLE

WIRE
RED
WHITE
BLACK
SHIELD

MOTOR SIDE

CONNECTOR EUMAX XMS3108F20-15S

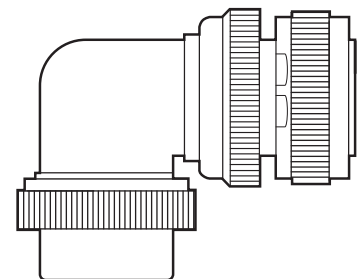

R.T.A. Srl
T +39 0382 929 855
www.rta.it
info@rta.it

R.T.A. Deutschland GmbH
T +49 211 74966860
www.rta-deutschland.de
info@rta-deutschland.de

R.T.A. IBERICA
T +34 936 388805
www.rta-iberica.es
info@rta-iberica.es

R.T.A. INDIA Pvt LTD
T +91 9422507445
www.rta-india.in
info@rta-india.in

CVMBAR90QHxxM

DIMENSIONS (UNIT:mm)

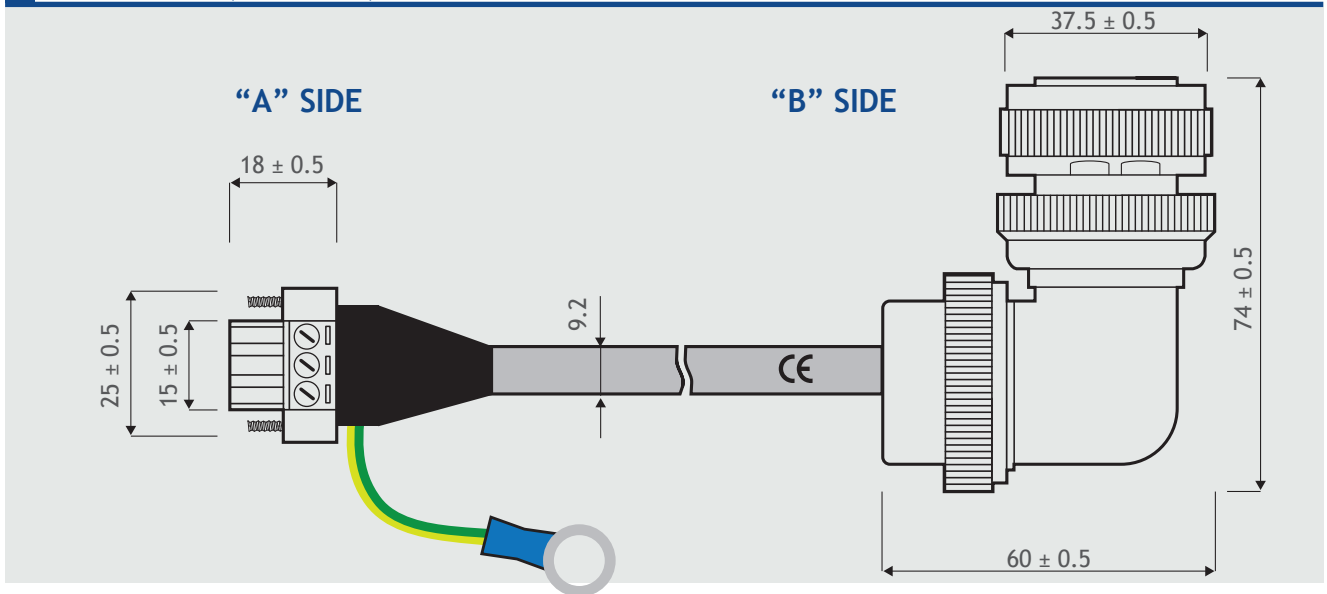

CABLE FEATURES

General info	(3xAWG13)
Cable diameter (mm)	9.2
Shielded	Yes
Flex chain	No
Curvature radius (xØ)	/
Cable speed (m/s)	/
Available lengths (m)	1, 2, 3.3, 5, 10
International Standard	RoHS, CE

"A" SIDE

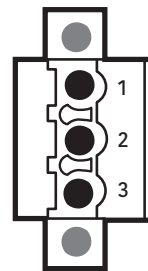

"B" SIDE

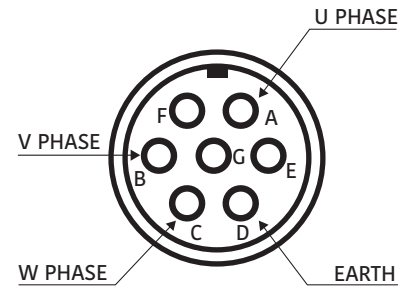

R.T.A. s.r.l. PAVIA (ITALY)

CONNECTORS FEATURES

DRIVE SIDE	CABLE	MOTOR SIDE
CONNECTOR PHOENIX MSTBT2.5/3-STF-5.08	WIRE	CONNECTOR EUMAX XMS3108F20-15S
1 [U]	RED	A
2 [V]	WHITE	B
3 [W]	BLACK	C
EARTH CABLE	SHIELD	D



R.T.A. Srl
T +39 0382 929 855
www.rta.it
info@rta.it

R.T.A. Deutschland GmbH
T +49 211 74966860
www.rta-deutschland.de
info@rta-deutschland.de

R.T.A. IBERICA
T +34 936 388805
www.rta-iberica.es
info@rta-iberica.es

R.T.A. INDIA Pvt LTD
T +91 9422507445
www.rta-india.in
info@rta-india.in

CVMFR1ARPM90xxM

DIMENSIONS (UNIT:mm)

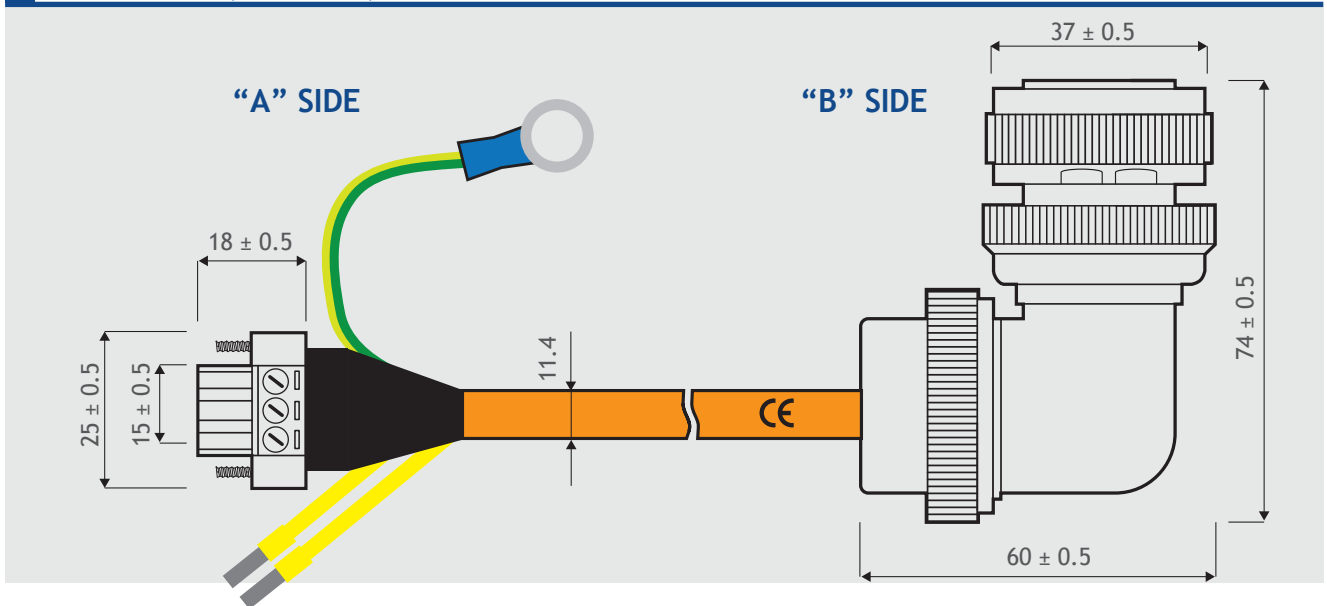

CABLE FEATURES

General info	(3xAWG13+2xAWG20)
Cable diameter (mm)	11.4
Shielded	Yes
Flex chain	Yes
Curvature radius (xØ)	7,5
Cable speed (m/s)	5
Available lengths (m)	1, 2, 3, 5, 10
International Standard	RoHS

"A" SIDE

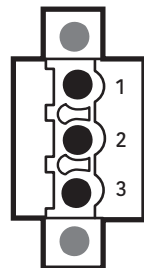

"B" SIDE

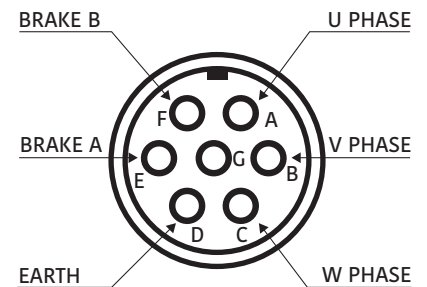

CONNECTORS FEATURES

DRIVE SIDE

CONNECTOR IC2.5/3-STF-5.08

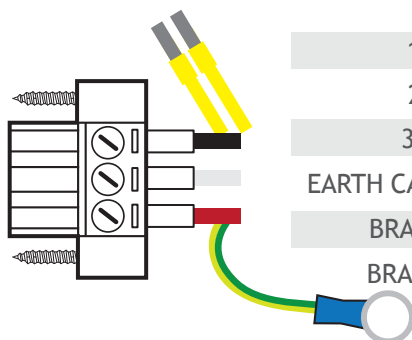

WIRE	CABLE	WIRE
1 [U]	RED	A
2 [V]	WHITE	B
3 [W]	BLACK	C
EARTH CABLE	SHIELD	D
BRAKE A	YELLOW	E
BRAKE B	YELLOW	F

CABLE

WIRE

MOTOR SIDE

CONNECTOR XMS3108F-20-15S

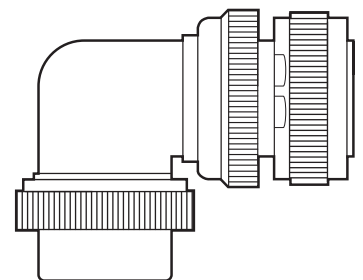

R.T.A. Srl
T +39 0382 929 855
www.rta.it
info@rta.it

R.T.A. Deutschland GmbH
T +49 211 74966860
www.rta-deutschland.de
info@rta-deutschland.de

R.T.A. IBERICA
T +34 936 388805
www.rta-iberica.es
info@rta-iberica.es

R.T.A. INDIA Pvt LTD
T +91 9422507445
www.rta-india.in
info@rta-india.in

CVMB3KR1AR90xxM

DIMENSIONS (UNIT:mm)

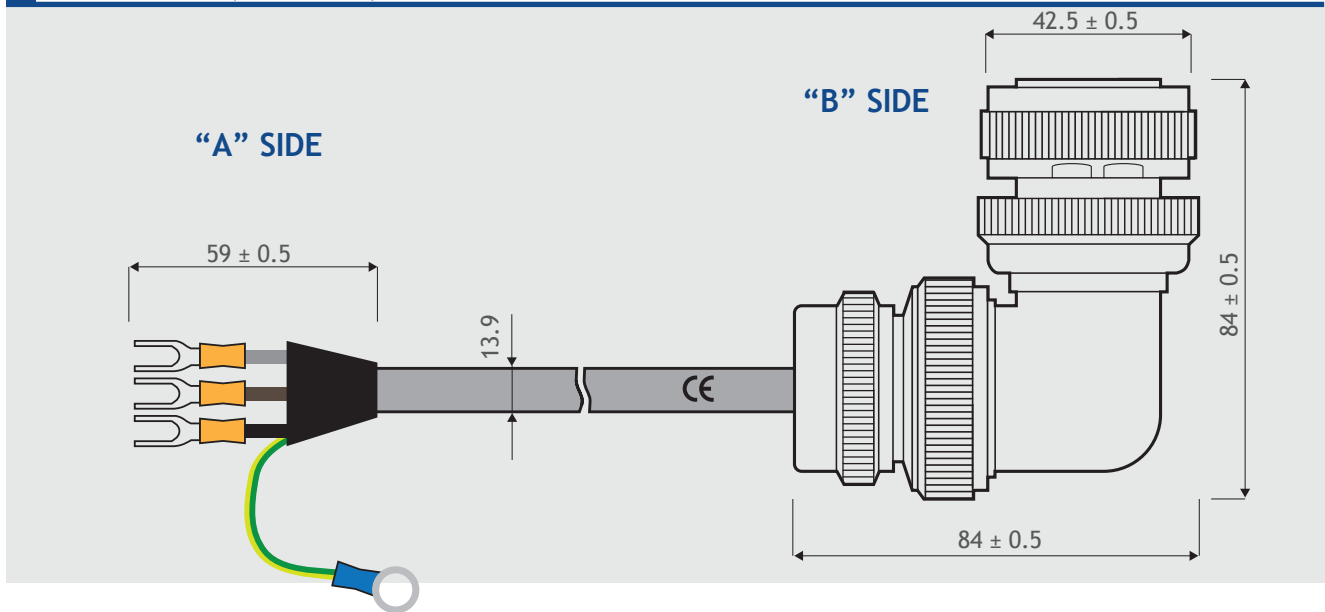

CABLE FEATURES

General info	(4xAWG11)
Cable diameter (mm)	13.9
Shielded	Yes
Flex chain	No
Curvature radius (xØ)	10
Cable speed (m/s)	-
Available lengths (m)	1, 2, 5, 10
International Standard	RoHS, CE

"A" SIDE



"B" SIDE

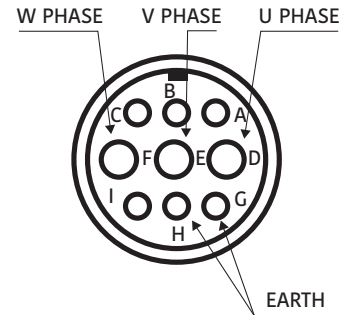

CONNECTORS FEATURES

DRIVE SIDE
PHOENIX CONTACT MSTBT2.5/3-STF-5.08

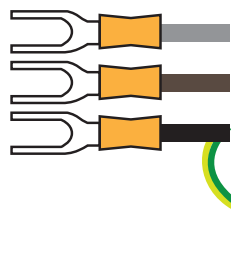

1 [U]
2 [V]
3 [W]
EARTH CABLE

CABLE

WIRE
RED
WHITE
BLACK
SHIELD

MOTOR SIDE

CONNECTOR XMS3108F-24-11S

D
E
F
G - H
SHORT CIRCUITED

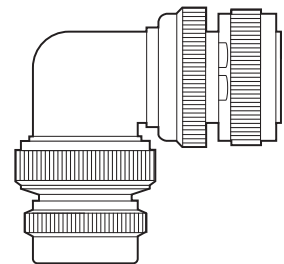

R.T.A. Srl
T +39 0382 929 855
www.rta.it
info@rta.it

R.T.A. Deutschland GmbH
T +49 211 74966860
www.rta-deutschland.de
info@rta-deutschland.de

R.T.A. IBERICA
T +34 936 388805
www.rta-iberica.es
info@rta-iberica.es

R.T.A. INDIA Pvt LTD
T +91 9422507445
www.rta-india.in
info@rta-india.in

CVMBR2ARPM90xxM

DIMENSIONS (UNIT:mm)

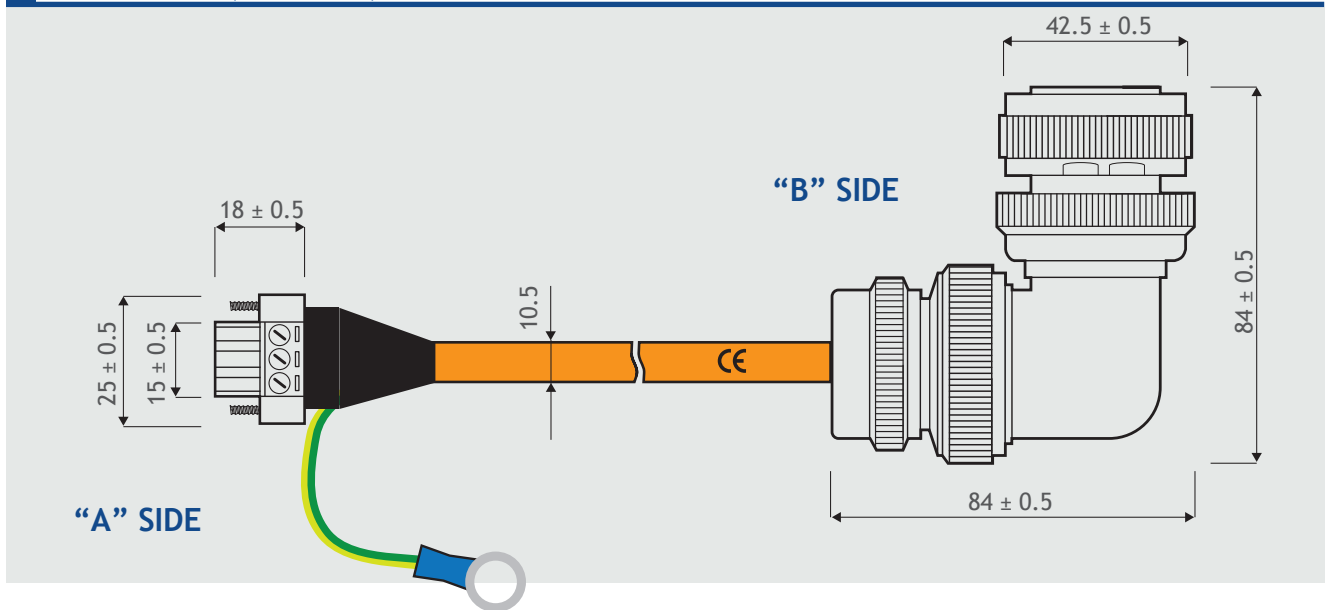

CABLE FEATURES

General info	(3xAWG13)
Cable diameter (mm)	10.5
Shielded	Yes
Flex chain	Yes
Curvature radius (xØ)	10
Cable speed (m/s)	3.3
Available lengths (m)	1, 2, 3, 5, 10
International Standard	RoHS, CE, UL

"A" SIDE

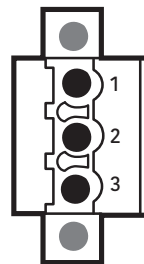

"B" SIDE

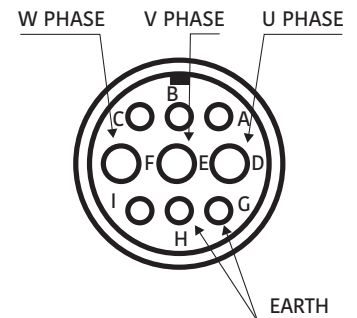

CONNECTORS FEATURES

DRIVE SIDE
PHOENIX CONTACT MSTBT2.5/3-STF-5.08

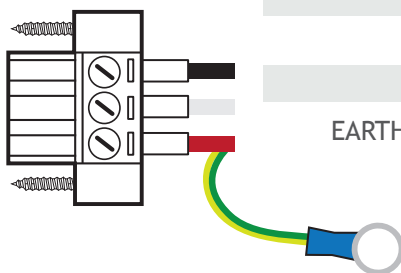

1 [U]	RED
2 [V]	WHITE
3 [W]	BLACK
EARTH CABLE	SHIELD

CABLE

WIRE	RED
	WHITE
	BLACK
SHIELD	SHIELD

MOTOR SIDE

CONNECTOR EUMAX XMS3108F-24-11S

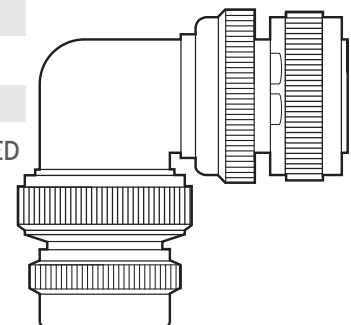

D	
E	
F	
G-H CIRCUITED	

CVMBR2AR90XXM

DIMENSIONS (UNIT:mm)

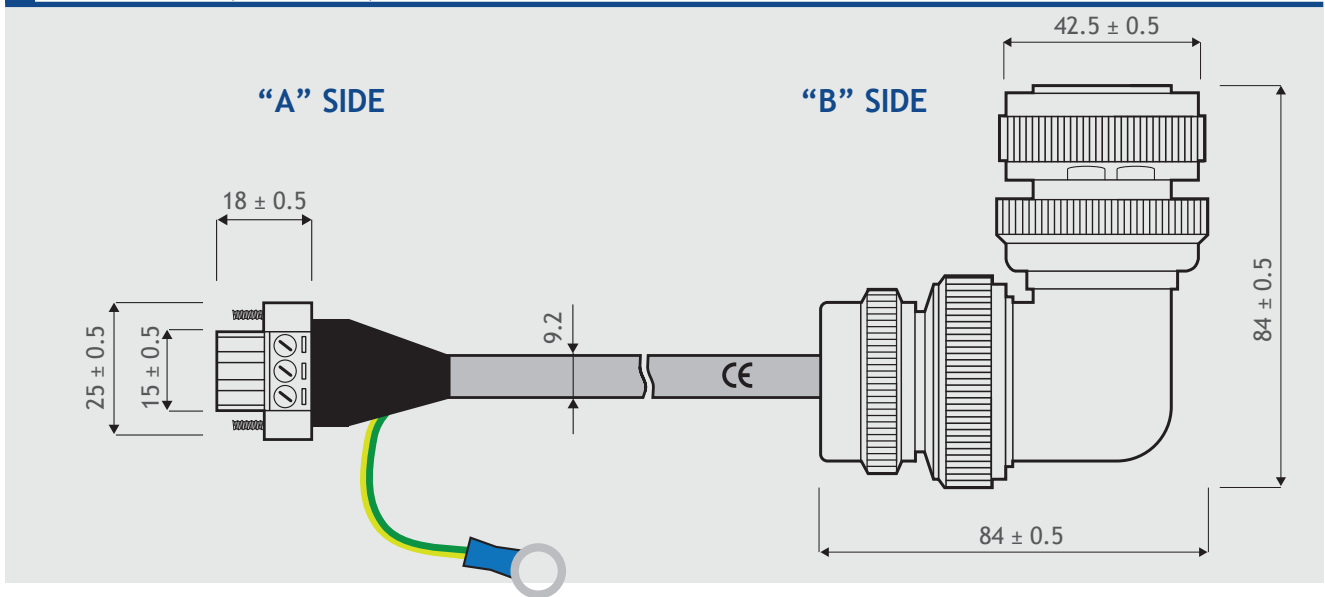

CABLE FEATURES

General info	(3xAWG13)
Cable diameter (mm)	9.2
Shielded	Yes
Flex chain	No
Curvature radius (xØ)	/
Cable speed (m/s)	/
Available lengths (m)	1, 2, 3, 5, 10
International Standard	RoHS, CE

"A" SIDE

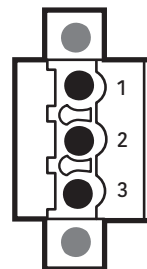

"B" SIDE

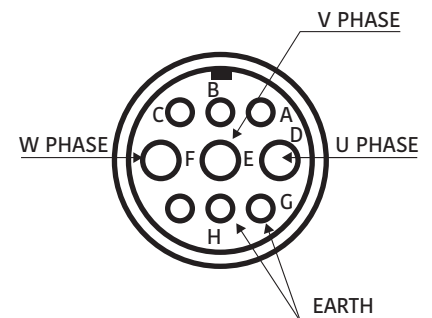

R.T.A. s.r.l. PAVIA (ITALY)

CONNECTORS FEATURES

DRIVE SIDE
PHOENIX CONTACT MSTBT2.5/3-STF-5.08

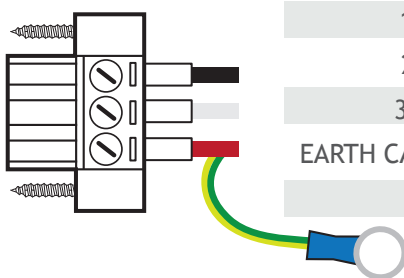

	CABLE WIRE	
1 [U]	RED	D
2 [V]	WHITE	E
3 [W]	BLACK	F
EARTH CABLE	SHIELD	G-H CIRCUITED

CABLE

WIRE
RED
WHITE
BLACK
SHIELD

MOTOR SIDE

CONNECTOR EUMAX XMS3108F-24-11S

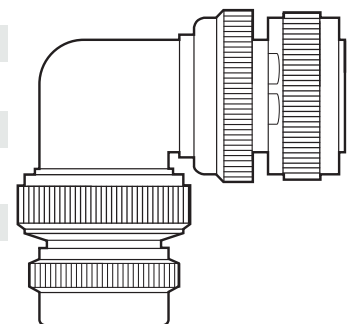

R.T.A. Srl
T +39 0382 929 855
www.rta.it
info@rta.it

R.T.A. Deutschland GmbH
T +49 211 74966860
www.rta-deutschland.de
info@rta-deutschland.de

R.T.A. IBERICA
T +34 936 388805
www.rta-iberica.es
info@rta-iberica.es

R.T.A. INDIA Pvt LTD
T +91 9422507445
www.rta-india.in
info@rta-india.in

CVMFR2ARPM90xxM

DIMENSIONS (UNIT:mm)

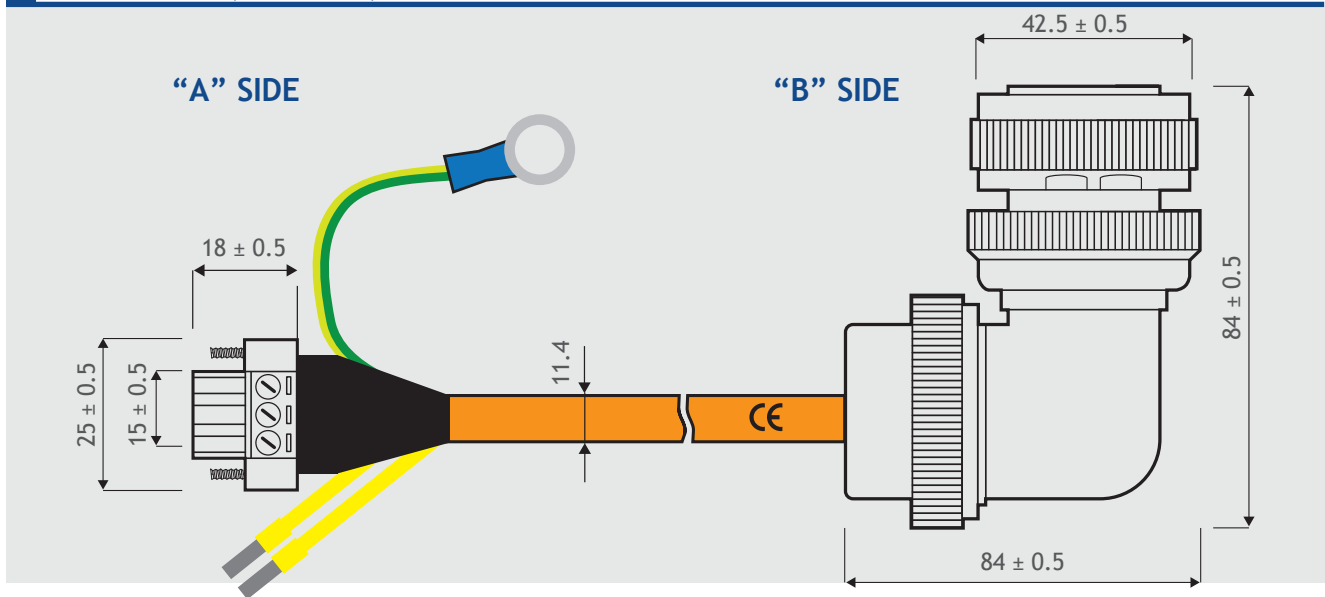

CABLE FEATURES

General info	(3xAWG13+2xAWG20)
Cable diameter (mm)	11.4
Shielded	Yes
Flex chain	Yes
Curvature radius (xØ)	7.5
Cable speed (m/s)	5
Available lengths (m)	1, 2, 3, 5, 10
International Standard	RoHS

"A" SIDE

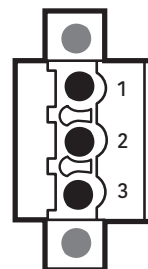

"B" SIDE

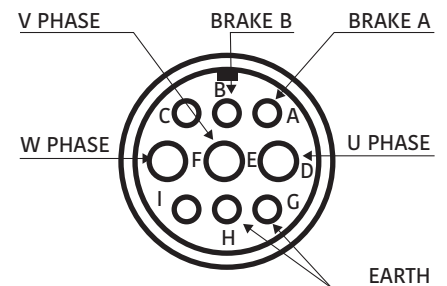

R.T.A. s.r.l. PAVIA (ITALY)

CONNECTORS FEATURES

DRIVE SIDE CONNECTOR IC2.5/3-STF-5.08	CABLE WIRE	MOTOR SIDE CONNECTOR XMS3108F-20-11S
1 [U]	RED	D
2 [V]	WHITE	E
3 [W]	BLACK	F
EARTH CABLE	SHIELD	G - H CIRCUITED
BRAKE A	YELLOW	A
BRAKE B	YELLOW	B



R.T.A. Srl
T +39 0382 929 855
www.rta.it
info@rta.it

R.T.A. Deutschland GmbH
T +49 211 74966860
www.rta-deutschland.de
info@rta-deutschland.de

R.T.A. IBERICA
T +34 936 388805
www.rta-iberica.es
info@rta-iberica.es

R.T.A. INDIA Pvt LTD
T +91 9422507445
www.rta-india.in
info@rta-india.in

CVEBRARPMxxM

DIMENSIONS (UNIT:mm)

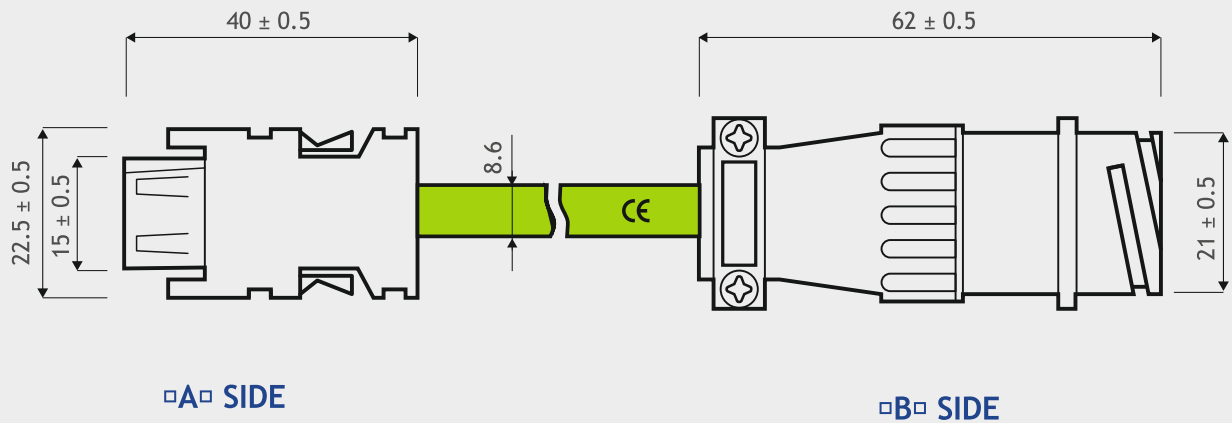

CABLE FEATURES

General info	(3x2AWG26+2xAWG22)
Cable diameter (mm)	8.6
Shielded	Yes
Flex chain	Yes
Curvature radius (xØ)	6
Cable speed (m/s)	4
Related Motors	R2 Series
Available lengths (m)	1, 2, 3.5, 5, 10
International Standard	CE, cUL, RoHS, CSA

A SIDE

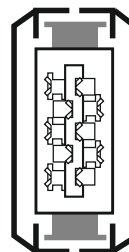

B SIDE

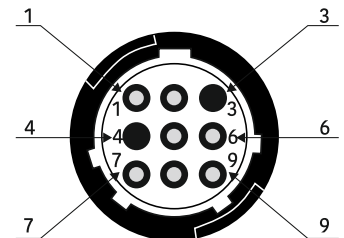

CONNECTORS FEATURES

DRIVE SIDE

PHOENIX CONTACT 3M 36210-0100PL

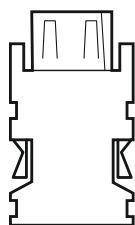

1	RED AWG22	7
2	BLACK AWG22	8
7	BROWN AWG26	1
8	BLUE AWG26	2
9	WHITE AWG26	5
10	PURPLE AWG26	6
CABLE GRIP PLATE	SHIELD	9

CABLE

WIRE

MOTOR SIDE

AMP 206705-2

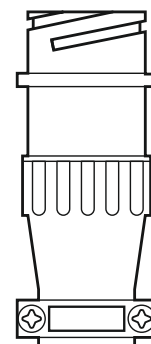

R.T.A. Srl
T +39 0382 929 855
www.rta.it
info@rta.it

R.T.A. Deutschland GmbH
T +49 211 74966860
www.rta-deutschland.de
info@rta-deutschland.de

R.T.A. IBERICA
T +34 936 388805
www.rta-iberica.es
info@rta-iberica.es

R.T.A. INDIA Pvt LTD
T +91 9422507445
www.rta-india.in
info@rta-india.in

CVEBRARxxM

DIMENSIONS (UNIT:mm)

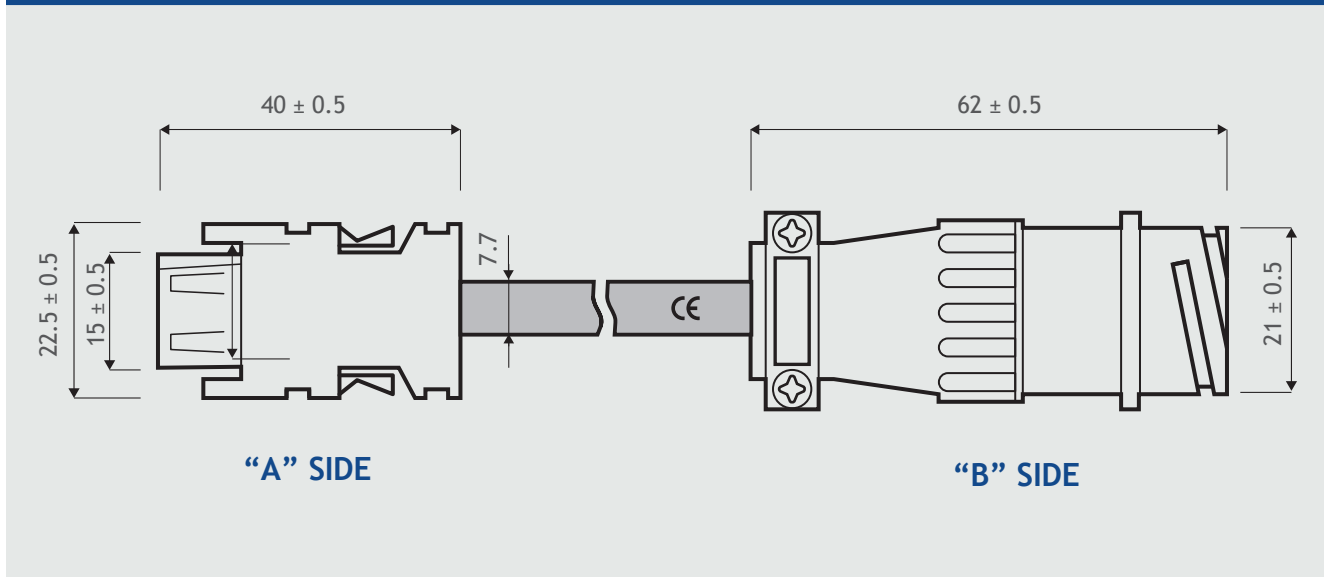

CABLE FEATURES

General info	(4x2AWG22)
Cable diameter (mm)	7.7
Shielded	Yes
Flex chain	No
Curvature radius (xØ)	6
Cable speed (m/s)	/
Related Motors	R2 Series
Available lengths (m)	1, 2, 3.5, 5, 10
International Standard	RoHS

"A" SIDE

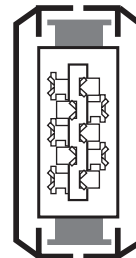

"B" SIDE

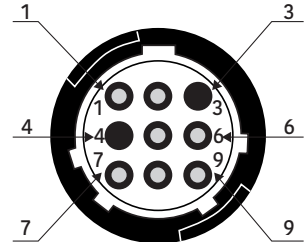

CONNECTORS FEATURES

DRIVE SIDE

PHOENIX CONTACT 3M 36210-0100PL

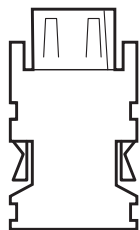

1	RED AWG22	7
2	BLACK AWG22	8
7	BROWN AWG22	1
8	BLUE AWG22	2
9	GREEN AWG22	5
10	PURPLE AWG22	6
CABLE GRIP PLATE	SHIELD	9

CABLE WIRE

MOTOR SIDE

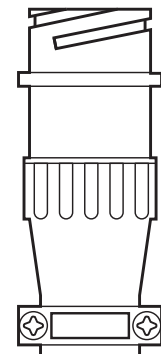

R.T.A. Srl
T +39 0382 929 855
www.rta.it
info@rta.it

R.T.A. Deutschland GmbH
T +49 211 74966860
www.rta-deutschland.de
info@rta-deutschland.de

R.T.A. IBERICA
T +34 936 388805
www.rta-iberica.es
info@rta-iberica.es

R.T.A. INDIA Pvt LTD
T +91 9422507445
www.rta-india.in
info@rta-india.in

CVEBAR1R2PMxxM

DIMENSIONS (UNIT:mm)

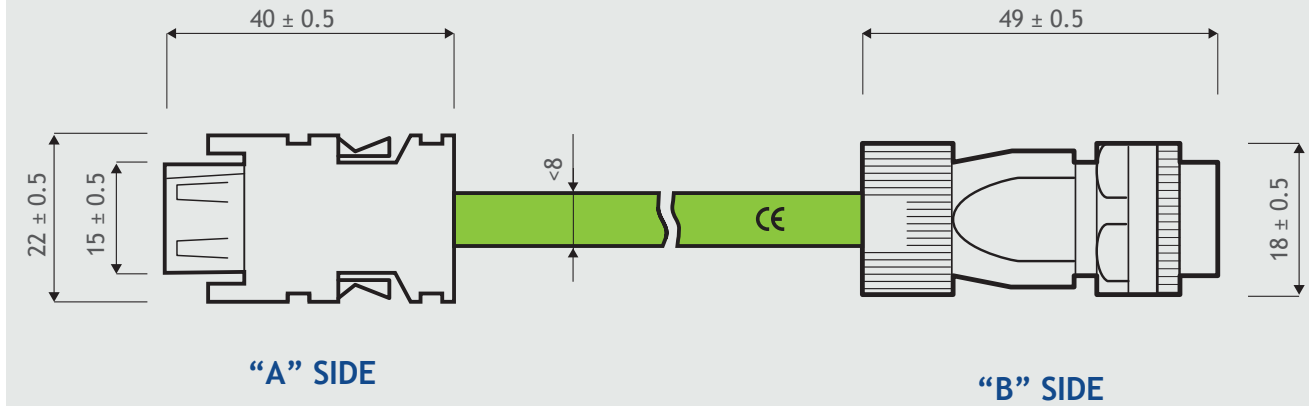

CABLE FEATURES

General info	(2xAWG26)+2XAWG22
Cable diameter (mm)	<math><8</math>
Shielded	Yes
Flex chain	Yes
Curvature radius (x \emptyset)	10
Cable speed (m/s)	3
Available lengths (m)	1, 2, 3.5, 5, 10
International Standard	CE, RoHS, UL, CSA

"A" SIDE

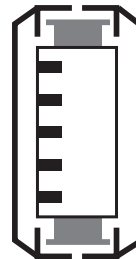

"B" SIDE

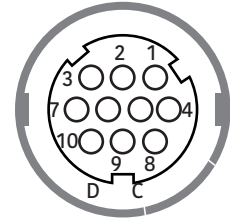

R.T.A. s.r.l. PAVIA (ITALY)

CONNECTORS FEATURES

DRIVE SIDE

CONNECTOR 3M 36210-0100PL

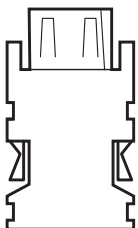

CABLE

WIRE

1	RED AWG22	9
2	BLACK AWG22	10
8	BLUE AWG22	2
7	BROWN AWG22	1
CABLE GRIP PLATE	SHIELD	7

MOTOR SIDE

CONNECTOR XM-JN2DS10SL-M-C

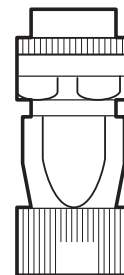

R.T.A. Srl
T +39 0382 929 855
www.rta.it
info@rta.it

R.T.A. Deutschland GmbH
T +49 211 74966860
www.rta-deutschland.de
info@rta-deutschland.de

R.T.A. IBERICA
T +34 936 388805
www.rta-iberica.es
info@rta-iberica.es

R.T.A. INDIA Pvt LTD
T +91 9422507445
www.rta-india.in
info@rta-india.in

CVEBAR1R2xxM

DIMENSIONS (UNIT:mm)

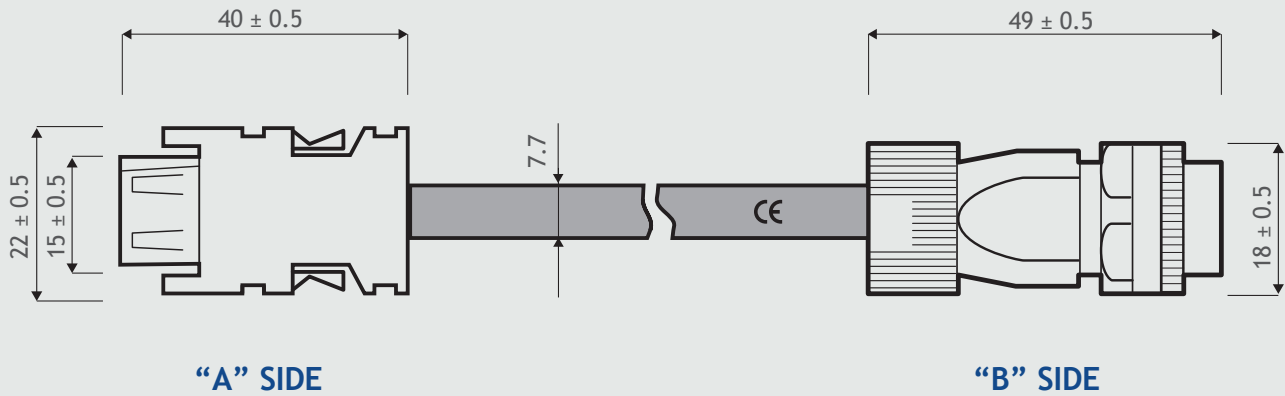

CABLE FEATURES

General info	(2xAWG26)+2XAWG22
Cable diameter (mm)	7.7
Shielded	Yes
Flex chain	No
Curvature radius (xØ)	/
Cable speed (m/s)	/
Available lengths (m)	1, 2, 3.3, 5, 10
International Standard	RoHS, CE

"A" SIDE

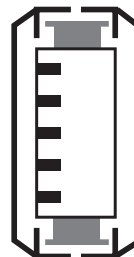

"B" SIDE

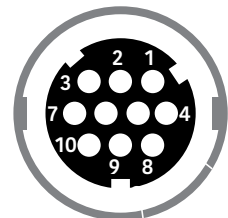

CONNECTORS FEATURES

DRIVE SIDE

CONNECTOR 3M 36210-0100PL

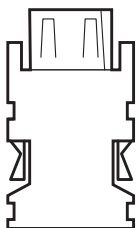

1	RED AWG22	9
2	BLACK AWG22	10
8	BLUE AWG22	2
7	BROWN AWG22	1
CABLE GRIP PLATE	SHIELD	7

CABLE

WIRE

MOTOR SIDE

CONNECTOR XM-JN2DS10SL-M-C

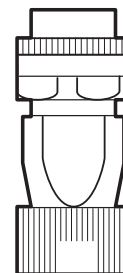

R.T.A. Srl
T +39 0382 929 855
www.rta.it
info@rta.it

R.T.A. Deutschland GmbH
T +49 211 74966860
www.rta-deutschland.de
info@rta-deutschland.de

R.T.A. IBERICA
T +34 936 388805
www.rta-iberica.es
info@rta-iberica.es

R.T.A. INDIA Pvt LTD
T +91 9422507445
www.rta-india.in
info@rta-india.in

CVEBAR90QHPMxxM

DIMENSIONS (UNIT:mm)

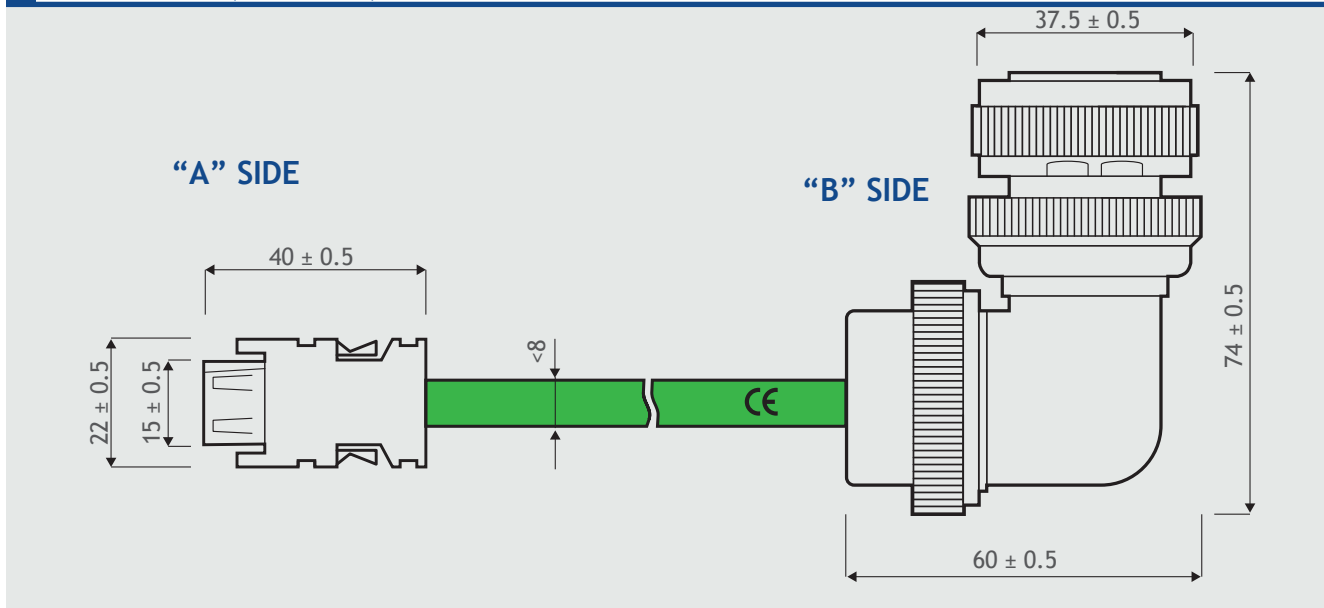

CABLE FEATURES

General info	(2xAWG26)+2XAWG22
Cable diameter (mm)	<math><8</math>
Shielded	Yes
Flex chain	Yes
Curvature radius (xØ)	10
Cable speed (m/s)	3
Available lengths (m)	1, 2, 3.3, 5, 10
International Standard	CE, RoHS, UL, CSA

"A" SIDE

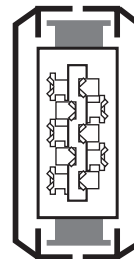

"B" SIDE

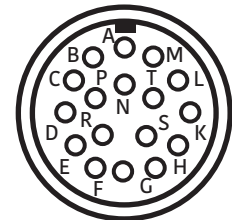

R.T.A. s.r.l. PAVIA (ITALY)

CONNECTORS FEATURES

DRIVE SIDE

CONNECTOR 3M 36210-0100PL

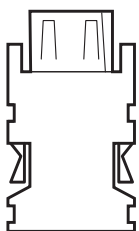

1	RED	H
2	BLACK	G
7	BROWN	E
8	BLUE	F
CABLE GRIP PLATE	SHIELD	J

CABLE

WIRE

MOTOR SIDE

CONNECTOR EUMAX XMS3108F20-29S

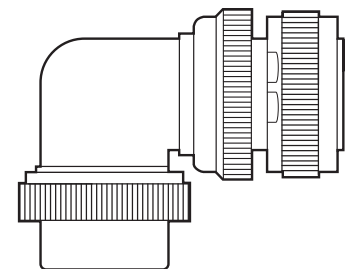

R.T.A. Srl
T +39 0382 929 855
www.rta.it
info@rta.it

R.T.A. Deutschland GmbH
T +49 211 74966860
www.rta-deutschland.de
info@rta-deutschland.de

R.T.A. IBERICA
T +34 936 388805
www.rta-iberica.es
info@rta-iberica.es

R.T.A. INDIA Pvt LTD
T +91 9422507445
www.rta-india.in
info@rta-india.in

CVEBAR90QHxxM

DIMENSIONS (UNIT:mm)

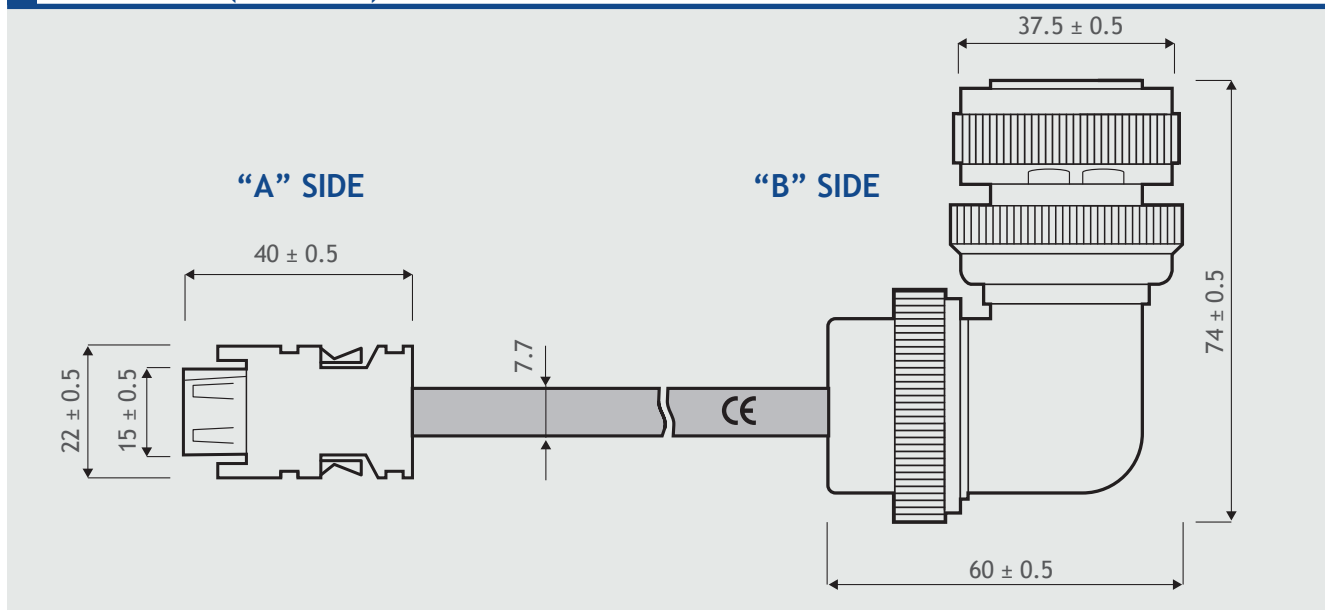

CABLE FEATURES

General info	(4x2AWG22)
Cable diameter (mm)	7.7
Shielded	Yes
Flex chain	No
Curvature radius (xØ)	/
Cable speed (m/s)	/
Available lengths (m)	1, 2, 3, 5, 10
International Standard	RoHS, CE

"A" SIDE

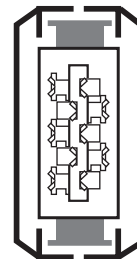

"B" SIDE

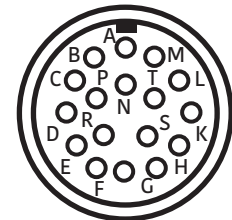

R.T.A. s.r.l. PAVIA (ITALY)

CONNECTORS FEATURES

DRIVE SIDE

CONNECTOR 3M 36210-0100PL

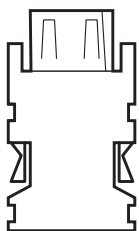

1
2
7
8
CABLE GRIP PLATE

CABLE

WIRE

RED
BLACK
BROWN
BLUE
SHIELD

MOTOR SIDE

CONNECTOR EUMAX XMS3108F20-29S

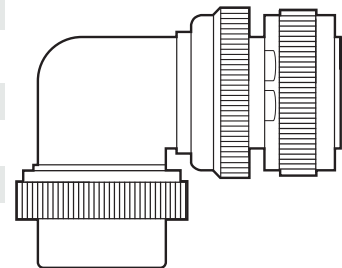

R.T.A. Srl
T +39 0382 929 855
www.rta.it
info@rta.it

R.T.A. Deutschland GmbH
T +49 211 74966860
www.rta-deutschland.de
info@rta-deutschland.de

R.T.A. IBERICA
T +34 936 388805
www.rta-iberica.es
info@rta-iberica.es

R.T.A. INDIA Pvt LTD
T +91 9422507445
www.rta-india.in
info@rta-india.in

CVIORS3ET02M

DIMENSIONS (UNIT:mm)

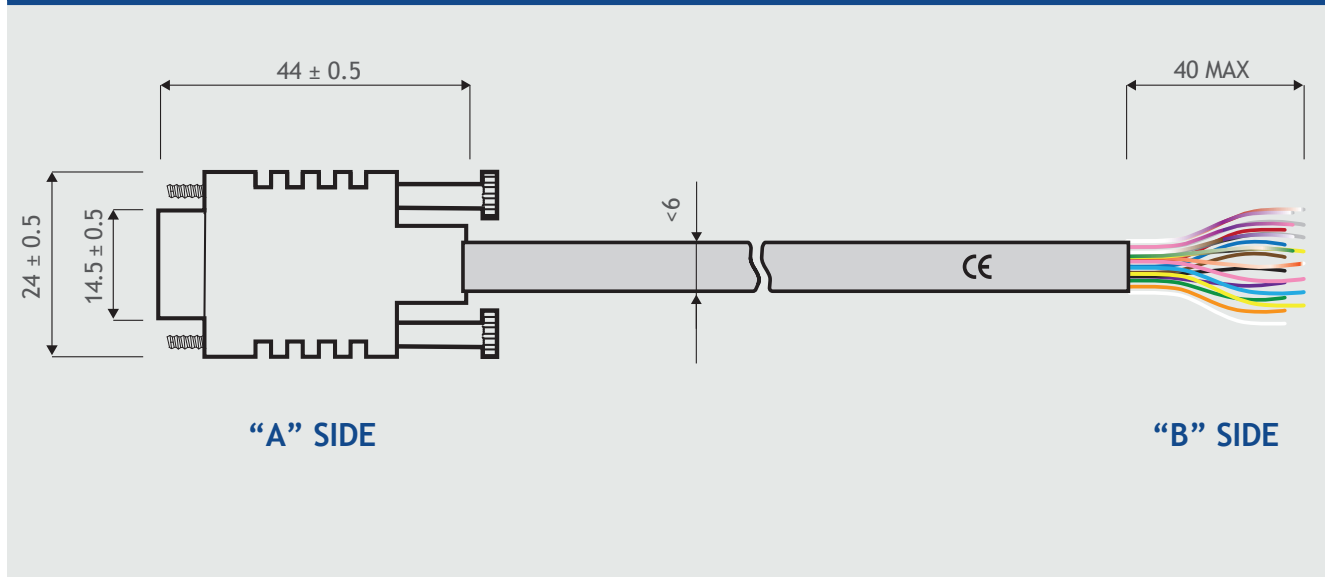

CABLE FEATURES

General info	(10x2xAWG28)
Cable diameter (mm)	<math><6</math>
Shielded	Yes
Flex chain	No
Curvature radius (x \emptyset)	/
Cable speed (m/s)	/
Available lengths (m)	2
International Standard	UL, CSA
Pairs	2) WHITE-BLUE; 4) BLACK-YELLOW; 6) WHITE-PURPLE; 8) WHITE-GREEN; 10) WHITE-BROWN; 26) WHITE-ORANGE

"A" SIDE



"B" SIDE

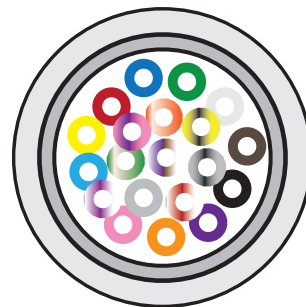

R.T.A. Srl
T +39 0382 929 855
www.rta.it
info@rta.it

R.T.A. Deutschland GmbH
T +49 211 74966860
www.rta-deutschland.de
info@rta-deutschland.de

R.T.A. IBERICA
T +34 936 388805
www.rta-iberica.es
info@rta-iberica.es

R.T.A. INDIA Pvt LTD
T +91 9422507445
www.rta-india.in
info@rta-india.in

CONNECTORS FEATURES

DRIVE SIDE CONNECTOR

CABLEE FREE WIRE

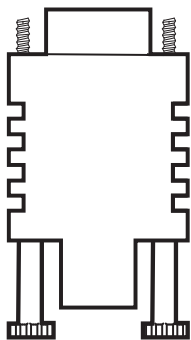

PIN	FUNCTIONALITY	COLORS
1	CONT_7+	BLUE
2	CONT_7-	WHITE-BLUE
3	CONT_1+	YELLOW
4	CONT_1-	BLACK-YELLOW
5	CONT_2+	PURPLE
6	CONT_2-	WHITE-PURPLE
7	CONT_3+	GREEN
8	CONT_3-	WHITE-GREEN
9	CONT_4+	BROWN
10	CONT_4-	WHITE-BROWN
11	CONT_5+	WHITE
12	CONT_5-	BLACK
13	SG	ORANGE
14	CONT_6+	RED
15	CONT_6-	WHITE-RED
16	OUT_1+	GREY
17	OUT_1-	BLACK-GREY
18	OUT_2+	PINK
19	OUT_2-	BLACK-PINK
20	NO CONNECTION	/
21	NO CONNECTION	/
22	NO CONNECTION	/
23	NO CONNECTION	/
24	NO CONNECTION	/
25	NO CONNECTION	/
26	SG	WHITE-ORANGE



R.T.A. s.r.l. PAVIA (ITALY)

Always refer to the manual that can be downloaded from the “RTA Download Area” for correct use.



R.T.A. Srl
T +39 0382 929 855
www.rta.it
info@rta.it

R.T.A. Deutschland GmbH
T +49 211 74966860
www.rta-deutschland.de
info@rta-deutschland.de

R.T.A. IBERICA
T +34 936 388805
www.rta-iberica.es
info@rta-iberica.es

R.T.A. INDIA Pvt LTD
T +91 9422507445
www.rta-india.in
info@rta-india.in

CVLBRR02M

DIMENSIONS (UNIT:mm)

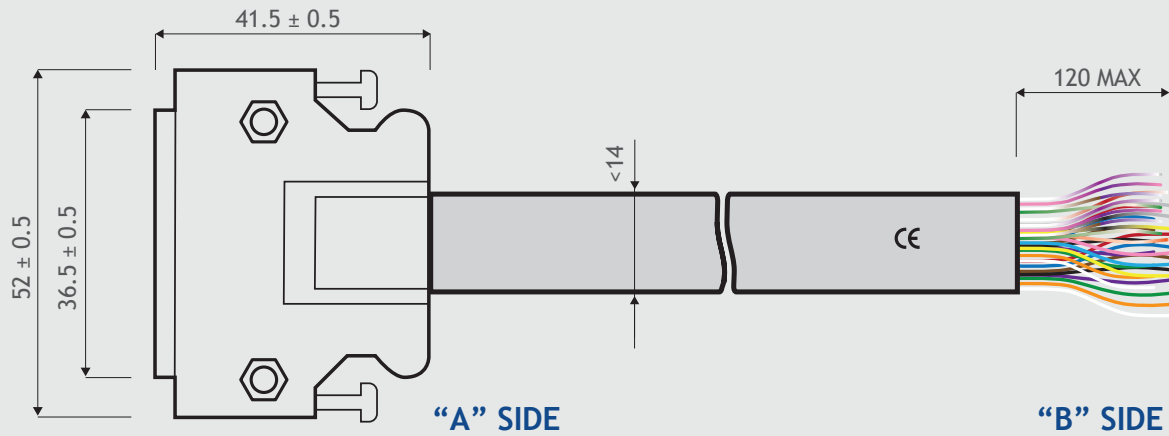

CABLE FEATURES

General info	(50xAWG23)
Cable diameter (mm)	<14
Shielded	Yes
Flex chain	No
Curvature radius (xØ)	7.5
Cable speed (m/s)	/
Available lengths (m)	2
International Standard	CE, RoHS

"A" SIDE



"B" SIDE

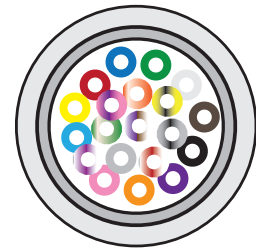

CONNECTORS FEATURES

DRIVE SIDE CONNECTOR

PIN	FUNCTIONALITY
1	BATTERY PLUS
2	BATTERY MINUS
3	A+ CHANNEL
4	A- CHANNEL
5	B+ CHANNEL
6	B- CHANNEL
7	Z+ CHANNEL
8	Z- CHANNEL

CABLE FREE WIRE

COLORS
WHITE
BROWN
GREEN
YELLOW
GREY
PINK
BLUE
RED

CONNECTORS FEATURES

DRIVE SIDE CONNECTOR

CABLE FREE WIRE

PIN	FUNCTIONALITY	COLORS
9	ENCODER SIGNAL OUTPUT	BLACK
10	ENCODER SIGNAL OUTPUT	PURPLE
11	Z CHANNEL	GREY-PINK
12	COMMON FOR PINS 3 TO 11	RED-BLUE
13	CONT7	WHITE-GREEN
14	PC-PWR	BROWN-GREEN
15	CONT8	WHITE-YELLOW
16	PC-PWR	YELLOW-BROWN
17	COMMON FOR PINS 18, 19	WHITE-GREY
18	F-TLA	GREY-BROWN
19	R-TLA	WHITE-PINK
20	COMMON FOR PIN 21	PINK-BROWN
21	V-REF / T-REF	WHITE-BLUE
22	T-COMP	BROWN-BLUE
23	COMMON FOR PIN 22	WHITE-RED
24	OUT-COM	BROWN-RED
25	OUT-COM	WHITE-BLACK
26	DIR +	BROWN-BLACK
27	DIR -	GREY-GREEN
28	STEP +	YELLOW-GREY
29	STEP -	PINK-GREEN
30	MON1	YELLOW-PINK
31	COMMON FOR PIN 30	GREEN-BLUE
32	CONT6	YELLOW-BLUE
33	CONT5	GREEN-RED
34	CONT4	YELLOW-RED
35	CONT3	GREEN-BLACK
36	CONT2	YELLOW-BLACK
37	CONT1	GREY-BLUE
38	OUT+ COM	PINK-BLUE
39	OUT1	GREY-RED
40	OUT2	PINK-RED
41	OUT3	GREY-BLACK
42	OUT4	PINK-BLACK
43	OUT5	BLUE-BLACK
44	OUT6	RED-BLACK
45	OUT7	WHITE-BROWN-BLACK
46	OUT8	YELLOW-GREEN-BLACK
47	COMMON FOR PINS 26, 27	GREY-PINK-BLACK
48	COMMON FOR PINS 28, 29	BLUE-RED-BLACK
49	OUT-PWR	WHITE-GREEN-BLACK
50	CONT-COM	GREEN-BROWN-BLACK

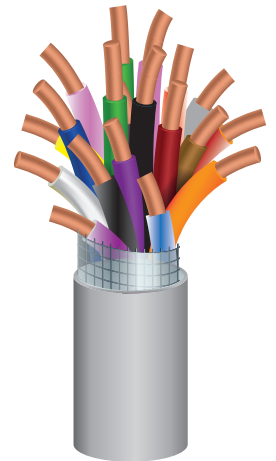
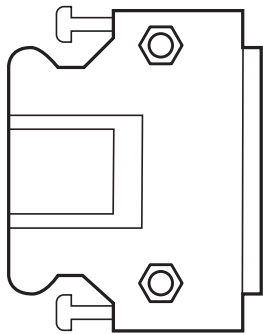

R.T.A. s.r.l. PAVIA (ITALY)

Always refer to the manual that can be downloaded from the “RTA Download Area” for correct use.



R.T.A. Srl
T +39 0382 929 855
www.rta.it
info@rta.it

R.T.A. Deutschland GmbH
T +49 211 74966860
www.rta-deutschland.de
info@rta-deutschland.de

R.T.A. IBERICA
T +34 936 388805
www.rta-iberica.es
info@rta-iberica.es

R.T.A. INDIA Pvt LTD
T +91 9422507445
www.rta-india.in
info@rta-india.in

CVSIORADO2M

DIMENSIONS (UNIT:mm)

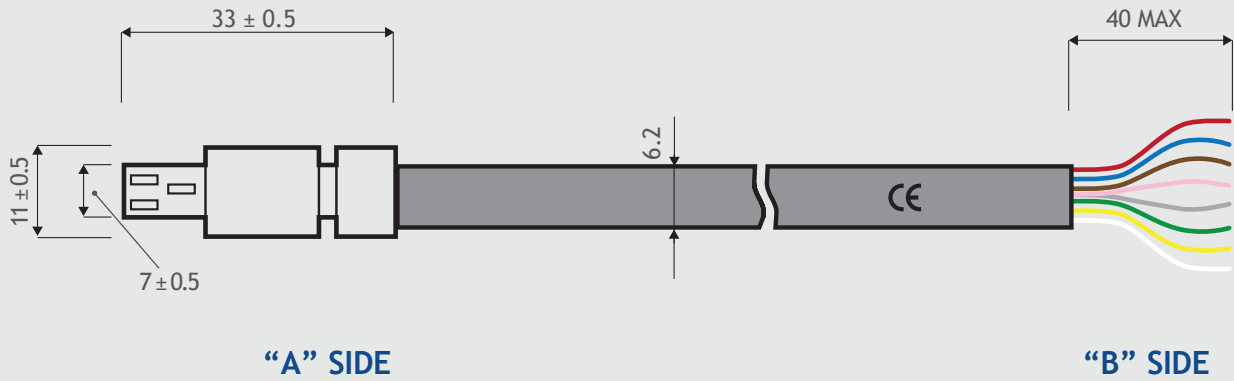

CABLE FEATURES

General info	(8xAWG23)
Cable diameter (mm)	6.2
Shielded	Yes
Flex chain	No
Curvature radius (xØ)	>15
Cable speed (m/s)	/
Available lengths (m)	2
International Standard	RoHS, CE

"A" SIDE



"B" SIDE

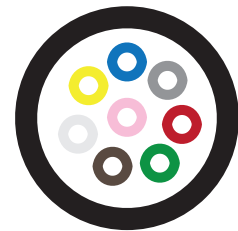

CONNECTORS FEATURES

DRIVE SIDE

CONNECTOR CONTACT NUMBER

FUNCTIONS

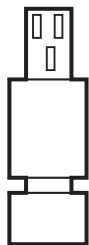

1	DO NOT USE
2	DO NOT USE
3	INPUT SAFETY FUNCTION 1-
4	INPUT SAFETY FUNCTION 1+
5	INPUT SAFETY FUNCTION 2-
6	INPUT SAFETY FUNCTION 2+
7	EDM- SIGNAL
8	EDM+ SIGNAL

METALLIC CABLE CLAMP

CABLE

WIRES COLOR

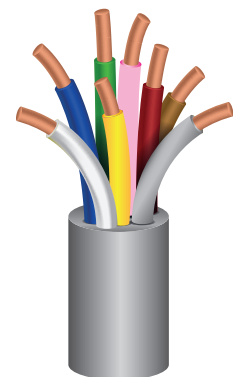

R.T.A. Srl
T +39 0382 929 855
www.rta.it
info@rta.it

R.T.A. Deutschland GmbH
T +49 211 74966860
www.rta-deutschland.de
info@rta-deutschland.de

R.T.A. IBERICA
T +34 936 388805
www.rta-iberica.es
info@rta-iberica.es

R.T.A. INDIA Pvt LTD
T +91 9422507445
www.rta-india.in
info@rta-india.in

CVAB4802M

DIMENSIONS (UNIT:mm)

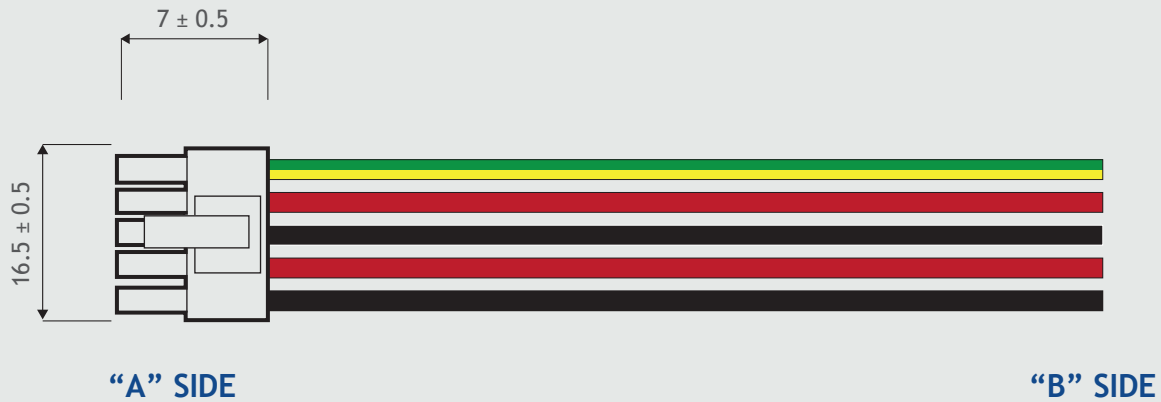

CABLE FEATURES

General info	(5xAWG18)
Wire diameter (mm)	/
Shielded	No
Flex chain	No
Curvature radius (xØ)	6
Cable speed (m/s)	/
Available lengths (m)	2
International Standard	UL, CSA

“A” SIDE



“B” SIDE



CONNECTORS FEATURES

DRIVE SIDE CONNECTOR

PIN	FUNCTIONLITY
1	FRAME GROUND / EARTH GROUND
2	5 V (CONTROL POWER)
3	0 VDC (CONTROL POWER)
4	48 V (MAIN POWER)
5	0 VDC (MAIN POWER)

CABLE FREE WIRES

COLORS
YELLOW/GREEN
RED
BLACK
RED
BLACK

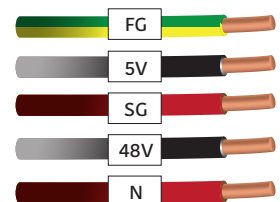

R.T.A. Srl
T +39 0382 929 855
www.rta.it
info@rta.it

R.T.A. Deutschland GmbH
T +49 211 74966860
www.rta-deutschland.de
info@rta-deutschland.de

R.T.A. IBERICA
T +34 936 388805
www.rta-iberica.es
info@rta-iberica.es

R.T.A. INDIA Pvt LTD
T +91 9422507445
www.rta-india.in
info@rta-india.in

CVAB48ET402M

DIMENSIONS (UNIT:mm)

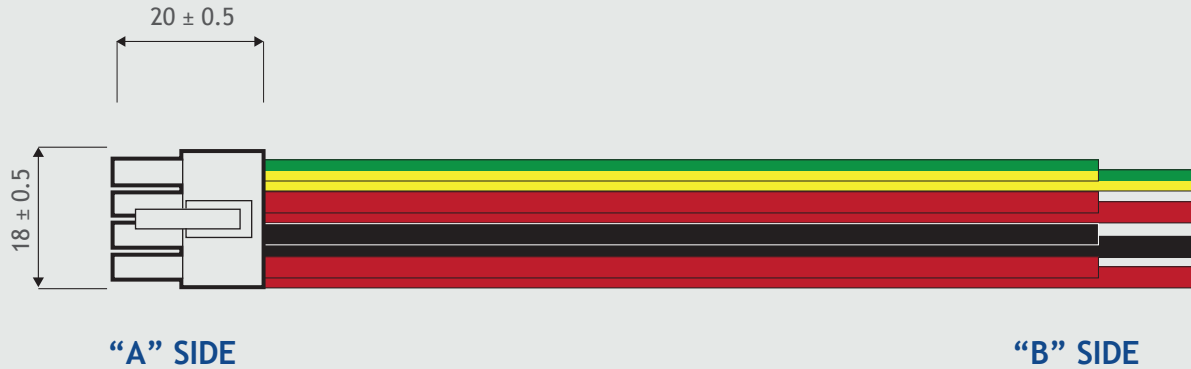

CABLE FEATURES

General info	(8xAWG18)
Wire diameter (mm)	/
Shielded	No
Flex chain	No
Curvature radius (xØ)	6
Cable speed (m/s)	/
Available lengths (m)	2
International Standard	UL, CSA

“A” SIDE

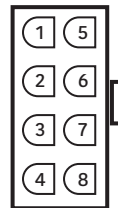

“B” SIDE



CONNECTORS FEATURES

PIN	DRIVE SIDE CONNECTOR	FUNCTIONLITY	COLORS	CABLE FREE WIRES
	1	FRAME GROUND / EARTH GROUND	YELLOW/GREEN	
5	FRAME GROUND / EARTH GROUND	YELLOW/GREEN	YELLOW/GREEN	FG
2	0 VDC (CONTROL POWER)	BLACK	BLACK	CN
6	24 V (CONTROL POWER)	RED	RED	24V
3	0 VDC (MAIN POWER)	BLACK	BLACK	N
4	48 V (MAIN POWER SUPPLY)	RED	RED	48V
7	0 VDC (MAIN POWER)	BLACK	BLACK	N
8	48 V (MAIN POWER SUPPLY)	RED	RED	48V

Always refer to the manual that can be downloaded from the “RTA Download Area” for correct use.



R.T.A. Srl
T +39 0382 929 855
www.rta.it
info@rta.it

R.T.A. Deutschland GmbH
T +49 211 74966860
www.rta-deutschland.de
info@rta-deutschland.de

R.T.A. IBERICA
T +34 936 388805
www.rta-iberica.es
info@rta-iberica.es

R.T.A. INDIA Pvt LTD
T +91 9422507445
www.rta-india.in
info@rta-india.in

CVMB48ET4PMxxM

DIMENSIONS (UNIT:mm)

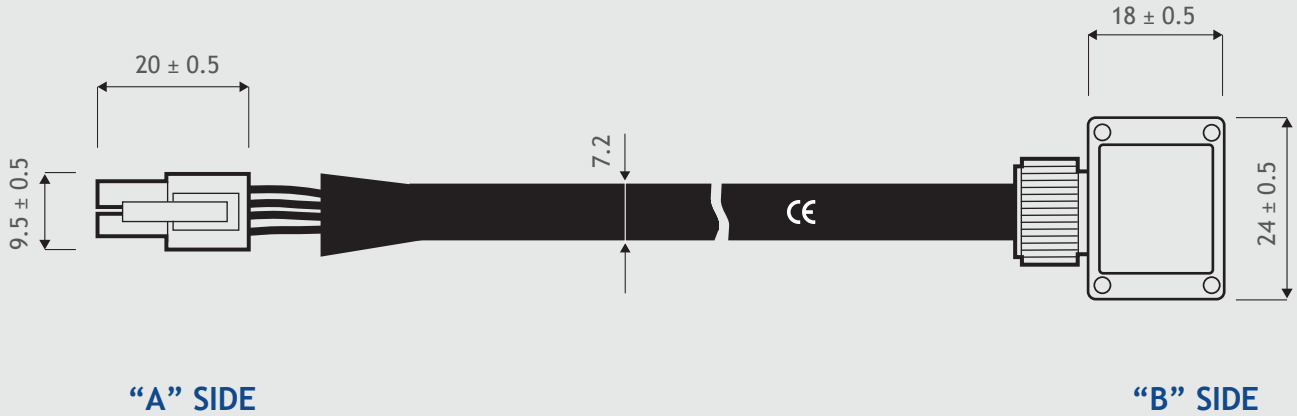

CABLE FEATURES

General info	(4xAWG19)
Cable diameter (mm)	7,2
Shielded	Yes
Flex chain	Yes
Curvature radius (xØ)	10
Cable speed (m/s)	3,6
Related Motors	48 VDC Motor Series
Available lengths (m)	1, 2, 3.5, 5
International Standard	UL, RoHS, CE

"A" SIDE

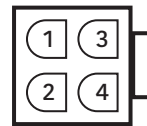

"B" SIDE

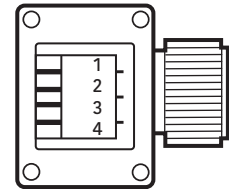

CONNECTORS FEATURES

DRIVE SIDE CONNECTOR

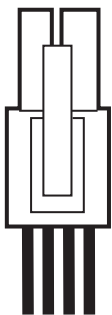

4 [U]	BLACK AWG19	1
3 [V]	BLACK AWG19	2
2 [W]	BLACK AWG19	3
1 [FG]	YELLOW/GREEN SHIELD AWG19	4

CABLE WIRES

MOTOR SIDE CONNECTOR

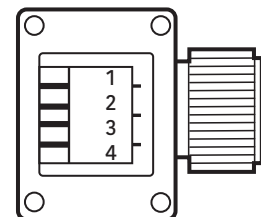

R.T.A. Srl
T +39 0382 929 855
www.rta.it
info@rta.it

R.T.A. Deutschland GmbH
T +49 211 74966860
www.rta-deutschland.de
info@rta-deutschland.de

R.T.A. IBERICA
T +34 936 388805
www.rta-iberica.es
info@rta-iberica.es

R.T.A. INDIA Pvt LTD
T +91 9422507445
www.rta-india.in
info@rta-india.in

CVMB48ETPMxxM

DIMENSIONS (UNIT:mm)

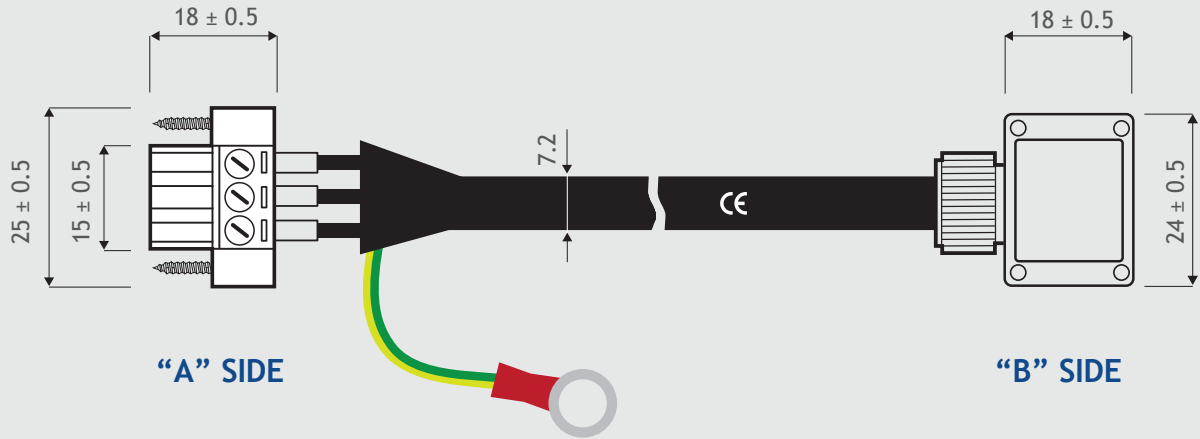

CABLE FEATURES

General info	(4xAWG19)
Cable diameter (mm)	7,2
Shielded	Yes
Flex chain	Yes
Curvature radius (xØ)	10
Cable speed (m/s)	3,6
Related Motors	48 VDC Motor Series
Available lengths (m)	1, 2, 3.5, 5
International Standard	UL, RoHS, CE

"A" SIDE

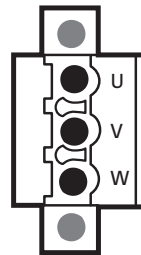

"B" SIDE

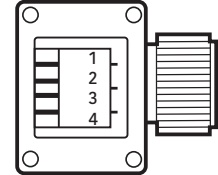

CONNECTORS FEATURES

DRIVE SIDE CONNECTOR	CABLE WIRES	MOTOR SIDE CONNECTOR
	1 [U] BLACK 1 AWG19	
	2 [V] BLACK 2 AWG19	
	3 [W] BLACK 3 AWG19	
	4 [FG] YELLOW/GREEN SHIELD AWG19	

R.T.A. s.r.l. PAVIA (ITALY)



R.T.A. Srl
T +39 0382 929 855
www.rta.it
info@rta.it

R.T.A. Deutschland GmbH
T +49 211 74966860
www.rta-deutschland.de
info@rta-deutschland.de

R.T.A. IBERICA
T +34 936 388805
www.rta-iberica.es
info@rta-iberica.es

R.T.A. INDIA Pvt LTD
T +91 9422507445
www.rta-india.in
info@rta-india.in

CVMB48PMxxM

DIMENSIONS (UNIT:mm)

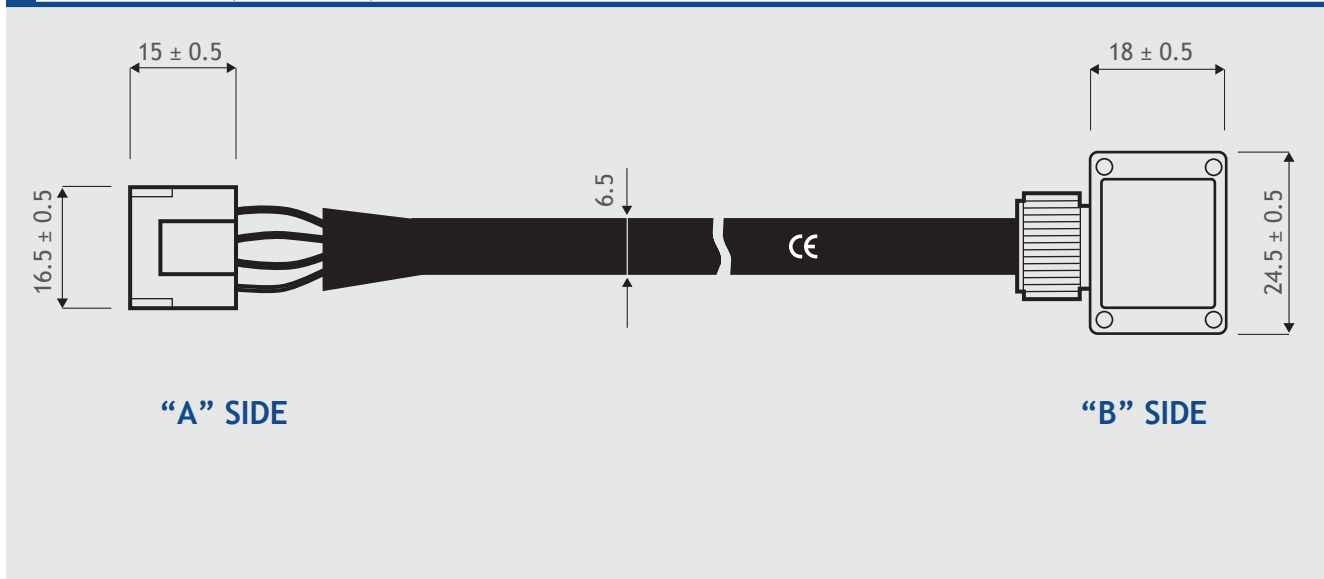

CABLE FEATURES

General info	(4xAWG19)
Cable diameter (mm)	7,2
Shielded	Yes
Flex chain	Yes
Curvature radius (xØ)	10
Cable speed (m/s)	3,6
Related Motors	48 VDC Motor Series
Available lengths (m)	1, 2, 3.5, 5
International Standard	UL, RoHS, CE

"A" SIDE

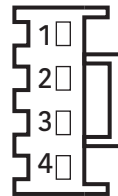

"B" SIDE

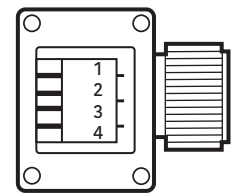

CONNECTORS FEATURES

DRIVE SIDE

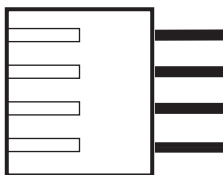

1 [U]	BLACK 1 AWG19	1
2 [V]	BLACK 2 AWG19	2
3 [W]	BLACK 3 AWG19	3
4 [FG]	YELLOW/GREEN SHIELD AWG	4

CABLE WIRE

MOTOR SIDE

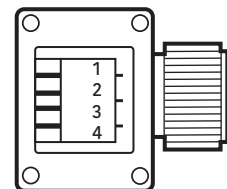

R.T.A. Srl
T +39 0382 929 855
www.rta.it
info@rta.it

R.T.A. Deutschland GmbH
T +49 211 74966860
www.rta-deutschland.de
info@rta-deutschland.de

R.T.A. IBERICA
T +34 936 388805
www.rta-iberica.es
info@rta-iberica.es

R.T.A. INDIA Pvt LTD
T +91 9422507445
www.rta-india.in
info@rta-india.in

CVEB48ETPMxxM

DIMENSIONS (UNIT:mm)

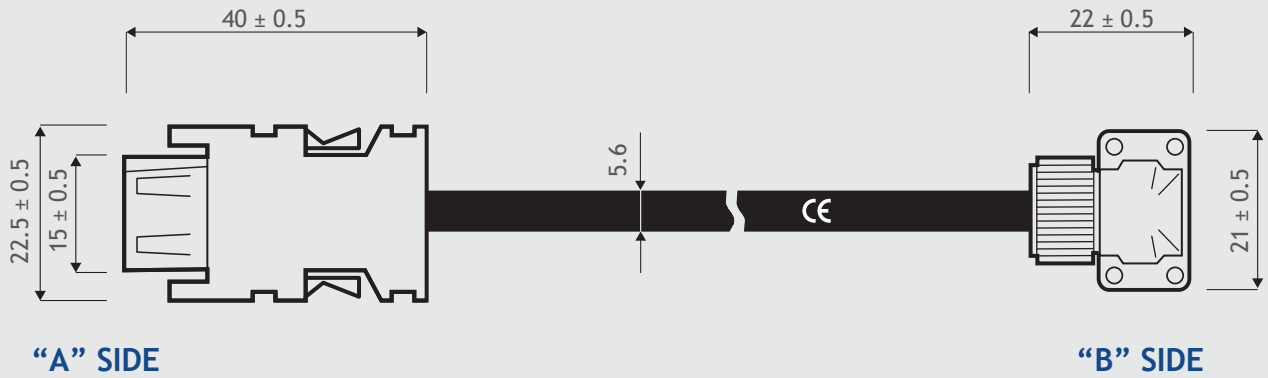

CABLE FEATURES

General info	(2x2xAWG24)+2xAWG22
Cable diameter (mm)	5,6
Shielded	Yes
Flex chain	Yes
Curvature radius (xØ)	10
Cable speed (m/s)	/
Related Motors	48 VDC Motor Series
Available lengths (m)	1, 2, 3.5, 5
International Standard	UL, RoHS, CE

"A" SIDE



"B" SIDE

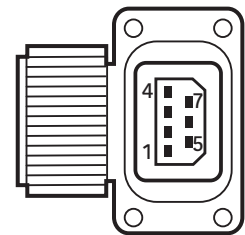

CONNECTORS FEATURES

DRIVE SIDE CONNECTOR	CABLE WIRE	MOTOR SIDE CONNECTOR
7	BLUE AWG24	3
8	WHITE-BLUE AWG24	4
1	RED AWG22	1
2	BLACK AWG22	2
CABLE GRIP PLATE	SHIELD	7

R.T.A. s.r.l. PAVIA (ITALY)



R.T.A. Srl
T +39 0382 929 855
www.rta.it
info@rta.it

R.T.A. Deutschland GmbH
T +49 211 74966860
www.rta-deutschland.de
info@rta-deutschland.de

R.T.A. IBERICA
T +34 936 388805
www.rta-iberica.es
info@rta-iberica.es

R.T.A. INDIA Pvt LTD
T +91 9422507445
www.rta-india.in
info@rta-india.in

CVEB48PMxxM

DIMENSIONS (UNIT:mm)

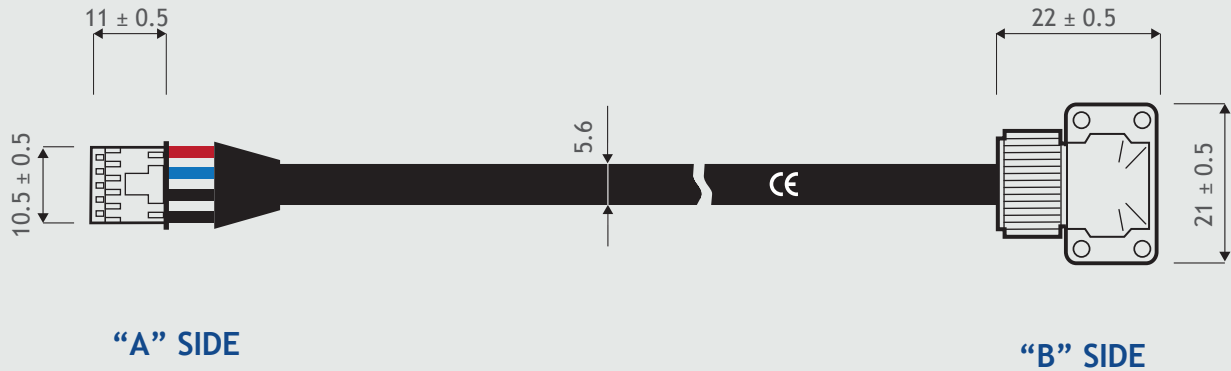

CABLE FEATURES

General info	(2x2xAWG24)+2xAWG22
Cable diameter (mm)	5,6
Shielded	Yes
Flex chain	Yes
Curvature radius (xØ)	10
Cable speed (m/s)	/
Related Motors	48 VDC Motor Series
Available lengths (m)	1, 2, 3.5, 5
International Standard	UL, RoHS, CSA

"A" SIDE

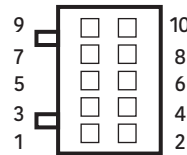

"B" SIDE

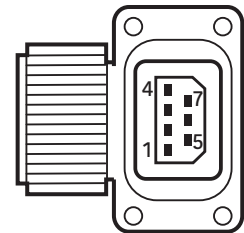

CONNECTORS FEATURES

DRIVE SIDE CONNECTOR		CABLE WIRE		MOTOR SIDE CONNECTOR
	NC	ORANGE AWG24	NC	
	NC	WHITE-ORANGE AWG24	NC	
	4	BLUE AWG24	4	
	3	WHITE-BLUE AWG24	3	
	1	RED AWG22	1	
	2	BLACK WG22	2	
CABLE GRIP PLATE	10	SHIELD	7	

R.T.A. s.r.l. PAVIA (ITALY)



R.T.A. Srl
T +39 0382 929 855
www.rta.it
info@rta.it

R.T.A. Deutschland GmbH
T +49 211 74966860
www.rta-deutschland.de
info@rta-deutschland.de

R.T.A. IBERICA
T +34 936 388805
www.rta-iberica.es
info@rta-iberica.es

R.T.A. INDIA Pvt LTD
T +91 9422507445
www.rta-india.in
info@rta-india.in

CVFB48PMxxM

DIMENSIONS (UNIT:mm)

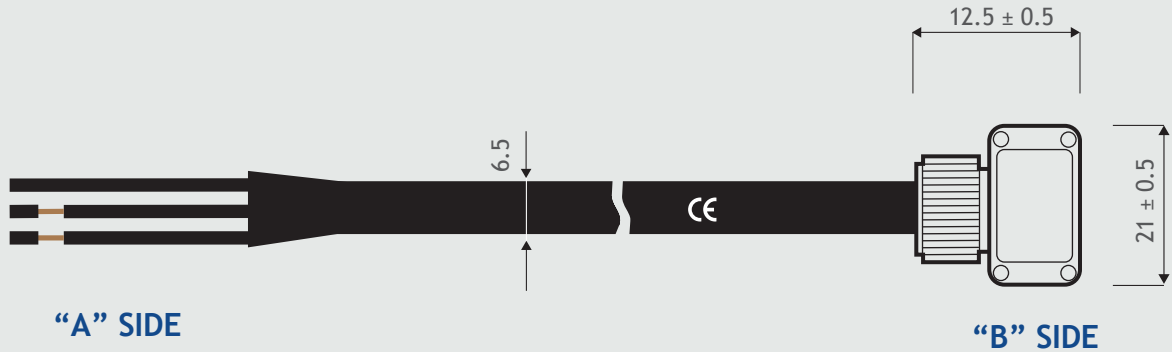

CABLE FEATURES

General info	(2xAWG20)
Cable diameter (mm)	6,5
Shielded	Yes
Flex chain	Yes
Curvature radius (xØ)	\
Cable speed (m/s)	\
Available lengths (m)	5, 10
International Standard	RoHS, CE

"A" SIDE

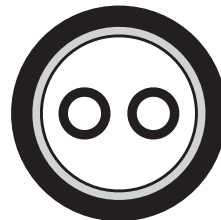

"B" SIDE

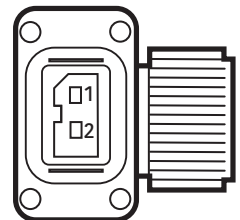

R.T.A. s.r.l. PAVIA (ITALY)

CONNECTORS FEATURES

SUPPLY

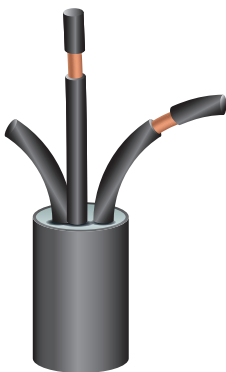

BRAKE A	BLACK AWG20	1
BRAKE B	BLACK AWG20	2
\	SHIELD	/

CABLE

FREE WIRES

ENCODER SIDE

CONNECTOR

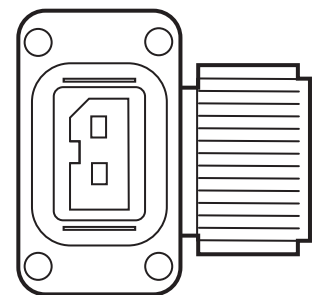

R.T.A. Srl
T +39 0382 929 855
www.rta.it
info@rta.it

R.T.A. Deutschland GmbH
T +49 211 74966860
www.rta-deutschland.de
info@rta-deutschland.de

R.T.A. IBERICA
T +34 936 388805
www.rta-iberica.es
info@rta-iberica.es

R.T.A. INDIA Pvt LTD
T +91 9422507445
www.rta-india.in
info@rta-india.in

CVSDB4802M

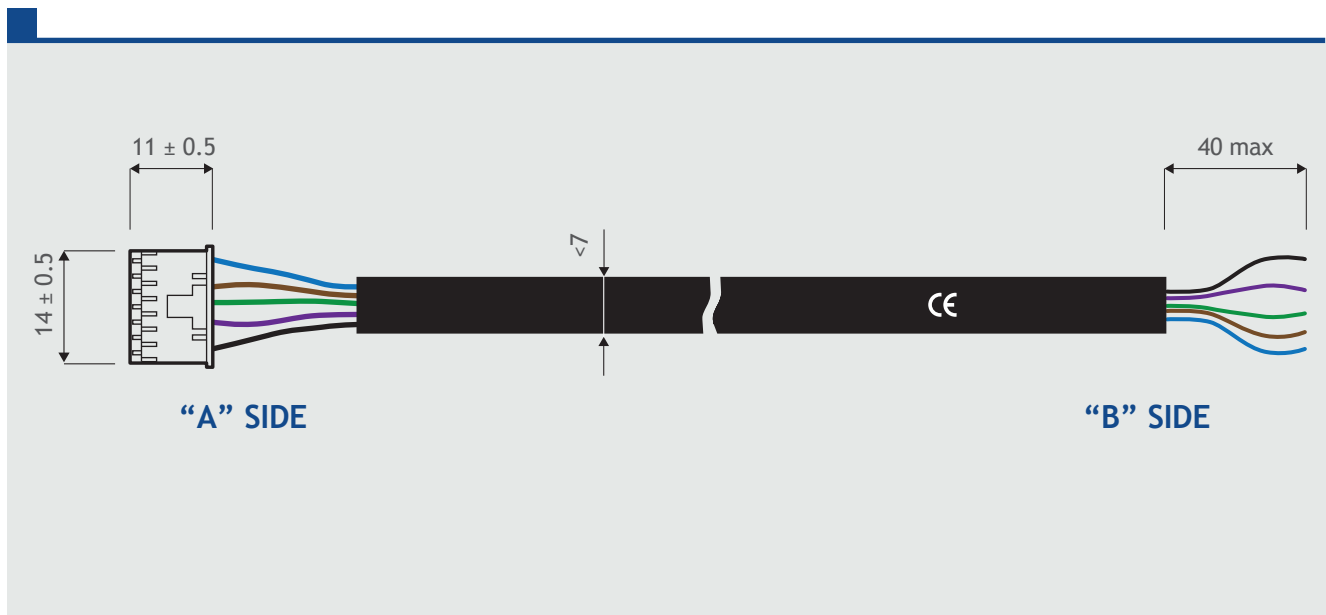

CABLE FEATURES

General info	3x(2xAWG26)
Cable diameter (mm)	<7
Shielded	Yes
Flex chain	No
Curvature radius (xØ)	/
Cable speed (m/s)	/
Related motors	48 VDC Motor Series
Available lengths (m)	2
International Standard	UL, CSA

R.T.A. s.r.l. PAVIA (ITALY)

"A" SIDE

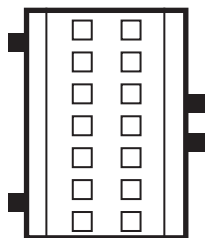

"B" SIDE

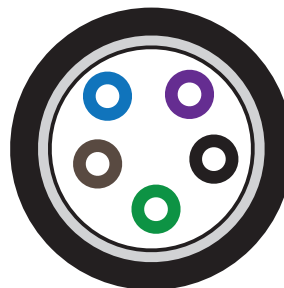

R.T.A. Srl
T +39 0382 929 855
www.rta.it
info@rta.it

R.T.A. Deutschland GmbH
T +49 211 74966860
www.rta-deutschland.de
info@rta-deutschland.de

R.T.A. IBERICA
T +34 936 388805
www.rta-iberica.es
info@rta-iberica.es

R.T.A. INDIA Pvt LTD
T +91 9422507445
www.rta-india.in
info@rta-india.in

CONNECTORS FEATURES

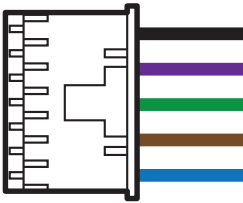
DRIVE SIDE CONNECTOR	PIN	FUNCTIONALITY	CABLE FREE WIRES
	1	NC	NC
	2	SHIELD	SHIELD
	3	NC	NC
	4	NC	NC
	5	NC	NC
	6	NC	NC
	7	NC	NC
	8	NC	NC
	9	NC	NC
	10	SIGNALS GROUND	BLACK
	11	DIRECTION (+)	BROWN
	12	DIRECTION (-)	BLUE
	13	STEP (+)	PINK
	14	STEP (-)	GREEN

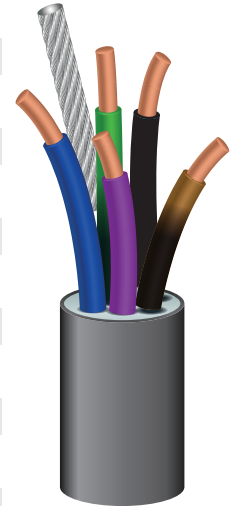

Always refer to the manual that can be downloaded from the “RTA Download Area” for correct use.



R.T.A. Srl
T +39 0382 929 855
www.rta.it
info@rta.it

R.T.A. Deutschland GmbH
T +49 211 74966860
www.rta-deutschland.de
info@rta-deutschland.de

R.T.A. IBERICA
T +34 936 388805
www.rta-iberica.es
info@rta-iberica.es

R.T.A. INDIA Pvt LTD
T +91 9422507445
www.rta-india.in
info@rta-india.in

CVIOB4802M

DIMENSIONS (UNIT:mm)

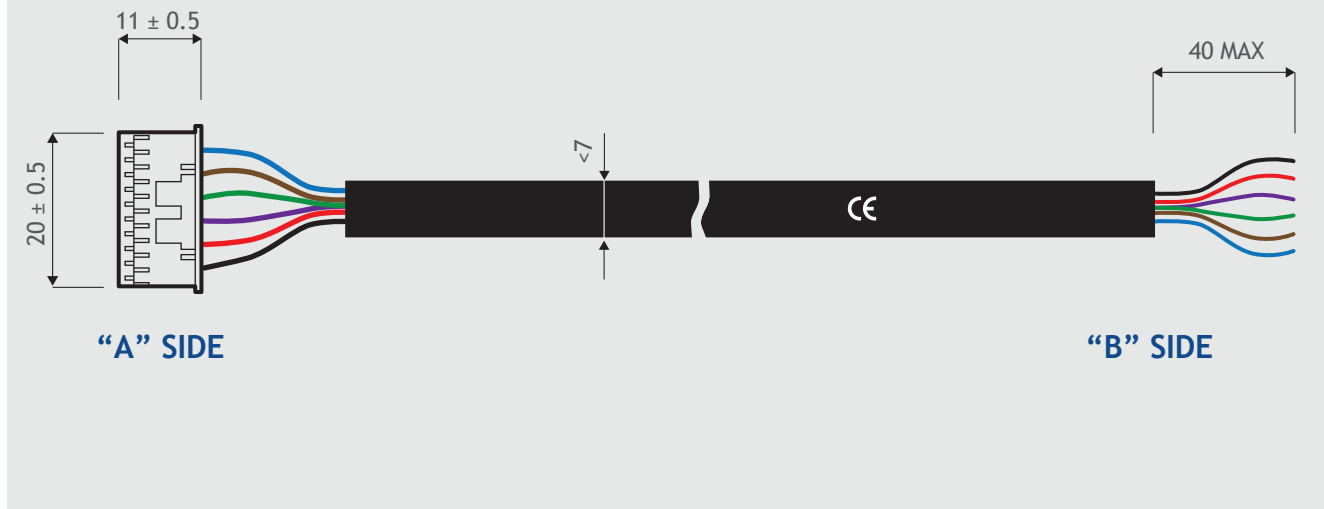

CABLE FEATURES

General info	3x(2xAWG26)
Cable diameter (mm)	<7
Shielded	Yes
Flex chain	No
Curvature radius (xØ)	/
Cable speed (m/s)	/
Related motors	48 VDC Motor Series
Available lengths (m)	2
International Standard	UL, CSA

R.T.A. s.r.l. PAVIA (ITALY)

"A" SIDE



"B" SIDE

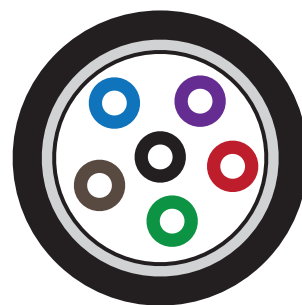

R.T.A. Srl
T +39 0382 929 855
www.rta.it
info@rta.it

R.T.A. Deutschland GmbH
T +49 211 74966860
www.rta-deutschland.de
info@rta-deutschland.de

R.T.A. IBERICA
T +34 936 388805
www.rta-iberica.es
info@rta-iberica.es

R.T.A. INDIA Pvt LTD
T +91 9422507445
www.rta-india.in
info@rta-india.in

CONNECTORS FEATURES

DRIVE SIDE CONNECTOR	PIN	FUNCTIONALITY	CABLE FREE WIRES
	1	COMMON INPUT	BROWN
	2	SHIELD	SHIELD
	3	CONT 1 (SERVO ON)	PINK
	4	CONT 2 (ALARM RES)	BLUE
	5	NC	NC
	6	NC	NC
	7	NC	NC
	8	NC	NC
	9	NC	NC
	10	NC	NC
	11	OUTPUT POWER	RED
	12	NC	NC
	13	NC	NC
	14	NC	NC
	15	NC	NC
	16	NC	NC
	17	NC	NC
	18	NC	NC
	19	COMMON OUTPUT	BLACK
	20	OUT 8 (FAULT)	GREEN

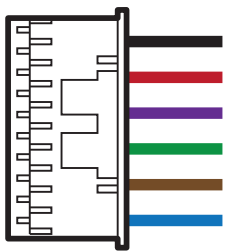

Always refer to the manual that can be downloaded from the “RTA Download Area” for correct use.



R.T.A. Srl
T +39 0382 929 855
www.rta.it
info@rta.it

R.T.A. Deutschland GmbH
T +49 211 74966860
www.rta-deutschland.de
info@rta-deutschland.de

R.T.A. IBERICA
T +34 936 388805
www.rta-iberica.es
info@rta-iberica.es

R.T.A. INDIA Pvt LTD
T +91 9422507445
www.rta-india.in
info@rta-india.in

CVIOB48ET02M

DIMENSIONS (UNIT:mm)

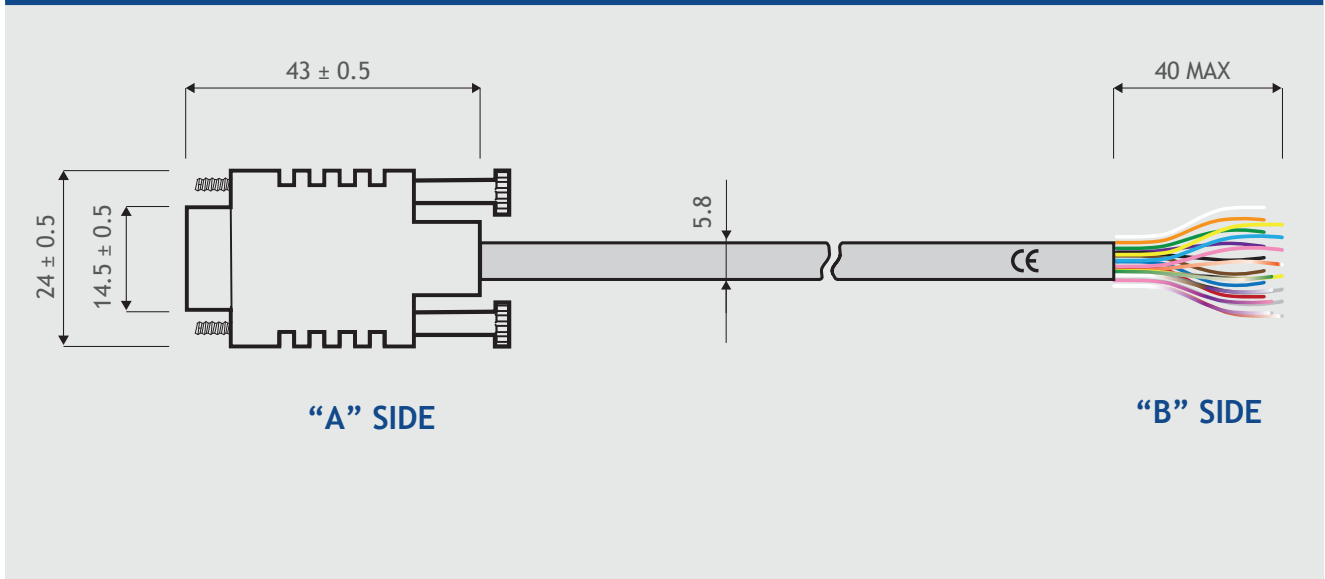

CABLE FEATURES

General info	(10x2xAWG28)
Cable diameter (mm)	5.8
Shielded	Yes
Flex chain	No
Curvature radius (xØ)	/
Cable speed (m/s)	/
Available lengths (m)	2
International Standard	UL, CSA

R.T.A. s.r.l. PAVIA (ITALY)

"A" SIDE



"B" SIDE

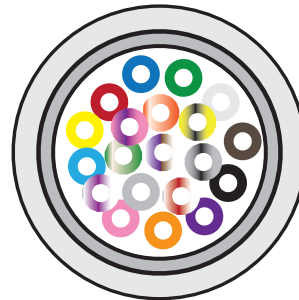

R.T.A. Srl
T +39 0382 929 855
www.rta.it
info@rta.it

R.T.A. Deutschland GmbH
T +49 211 74966860
www.rta-deutschland.de
info@rta-deutschland.de

R.T.A. IBERICA
T +34 936 388805
www.rta-iberica.es
info@rta-iberica.es

R.T.A. INDIA Pvt LTD
T +91 9422507445
www.rta-india.in
info@rta-india.in

CONNECTORS FEATURES

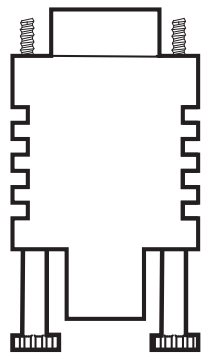

DRIVE SIDE CONNECTOR

CABLE FREE WIRES

PIN	FUNCTIONALITY	COLORS
1	NO CONNECTION	/
2	NO CONNECTION	/
3	CONT_1+	YELLOW
4	CONT_1-	YELLOW-BLACK
5	CONT_2+	PURPLE
6	CONT_2-	WHITE-PURPLE
7	CONT_3+	GREEN
8	CONT_3-	WHITE-GREEN
9	CONT_4+	BROWN
10	CONT_4-	BROWN-WHITE
11	CONT_5+	WHITE
12	CONT_5-	BLACK
13	SG	ORANGE
14	CONT_6+	RED
15	CONT_6-	WHITE-RED
16	OUT_1+	GREY
17	OUT_1-	GREY-BLACK
18	OUT_2+	PINK
19	OUT_2-	PINK-BLACK
20	NO CONNECTION	/
21	NO CONNECTION	/
22	NO CONNECTION	/
23	NO CONNECTION	/
24	NO CONNECTION	/
25	NO CONNECTION	/
26	SG	WHITE-ORANGE

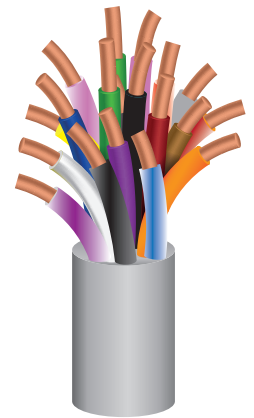

Always refer to the manual that can be downloaded from the “RTA Download Area” for correct use.



R.T.A. Srl
T +39 0382 929 855
www.rta.it
info@rta.it

R.T.A. Deutschland GmbH
T +49 211 74966860
www.rta-deutschland.de
info@rta-deutschland.de

R.T.A. IBERICA
T +34 936 388805
www.rta-iberica.es
info@rta-iberica.es

R.T.A. INDIA Pvt LTD
T +91 9422507445
www.rta-india.in
info@rta-india.in

CVMBG1G2AR90PMxxM

DIMENSIONS (UNIT:mm)

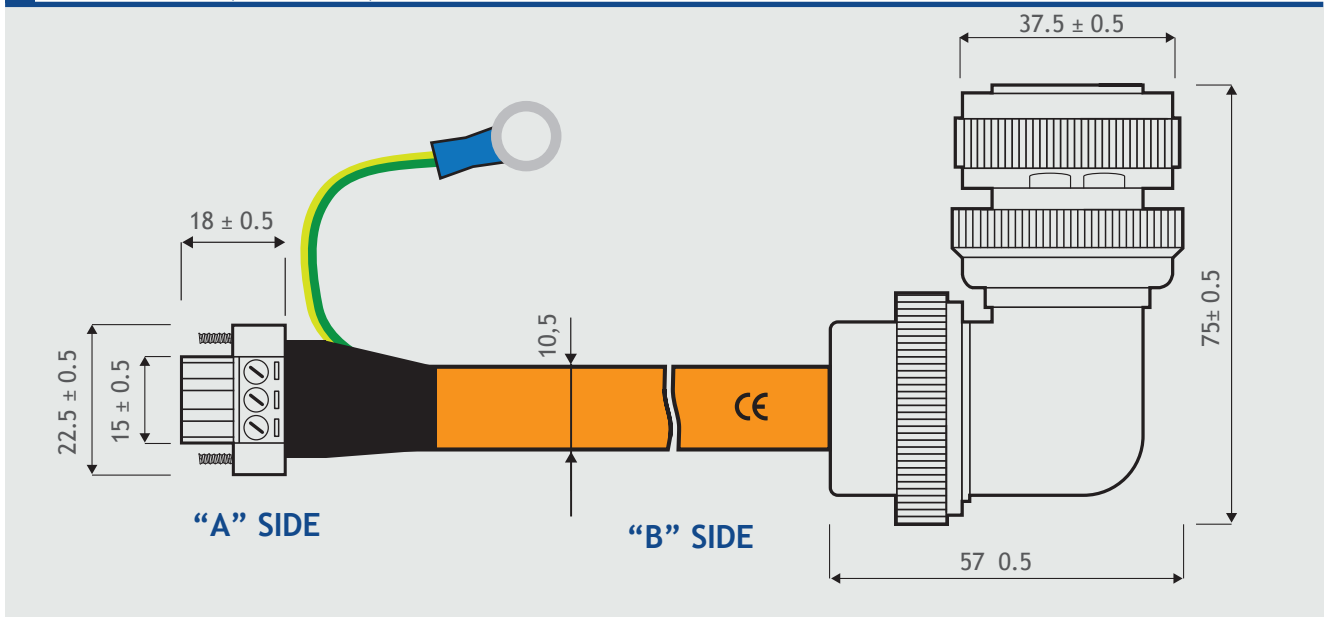

CABLE FEATURES

General info	(3xAWG13)
Cable diameter (mm)	10,5
Shielded	Yes
Flex chain	Yes
Curvature radius (xØ)	10
Cable speed (m/s)	3,3
Available lengths (m)	1, 2, 3, 5, 10
International Standard	RoHS, CE

"A" SIDE

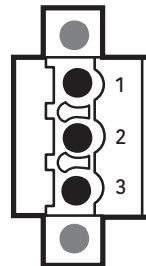

"B" SIDE

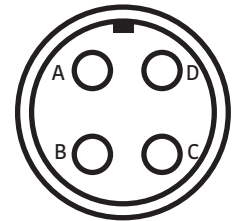

CONNECTORS FEATURES

DRIVE SIDE

CONNECTOR PHOENIXMSTBT2.5/3-STF-5.08

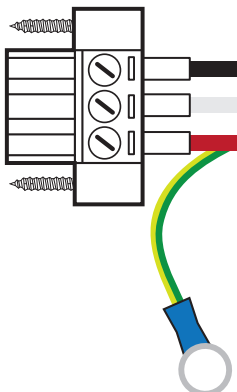

1 [U]
2 [V]
3 [W]
EARTH CABLE

CABLE

WIRE
RED
WHITE
BLACK
SHIELD

MOTOR SIDE

CONNECTOR EUMAX XMS3108E20-4SG

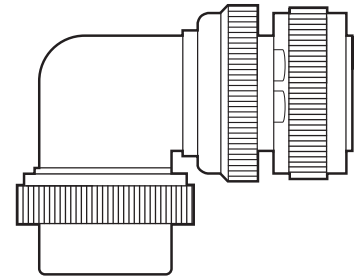

R.T.A. Srl
T +39 0382 929 855
www.rta.it
info@rta.it

R.T.A. Deutschland GmbH
T +49 211 74966860
www.rta-deutschland.de
info@rta-deutschland.de

R.T.A. IBERICA
T +34 936 388805
www.rta-iberica.es
info@rta-iberica.es

R.T.A. INDIA Pvt LTD
T +91 9422507445
www.rta-india.in
info@rta-india.in

CVMBG1G2AR90xxM

DIMENSIONS (UNIT:mm)

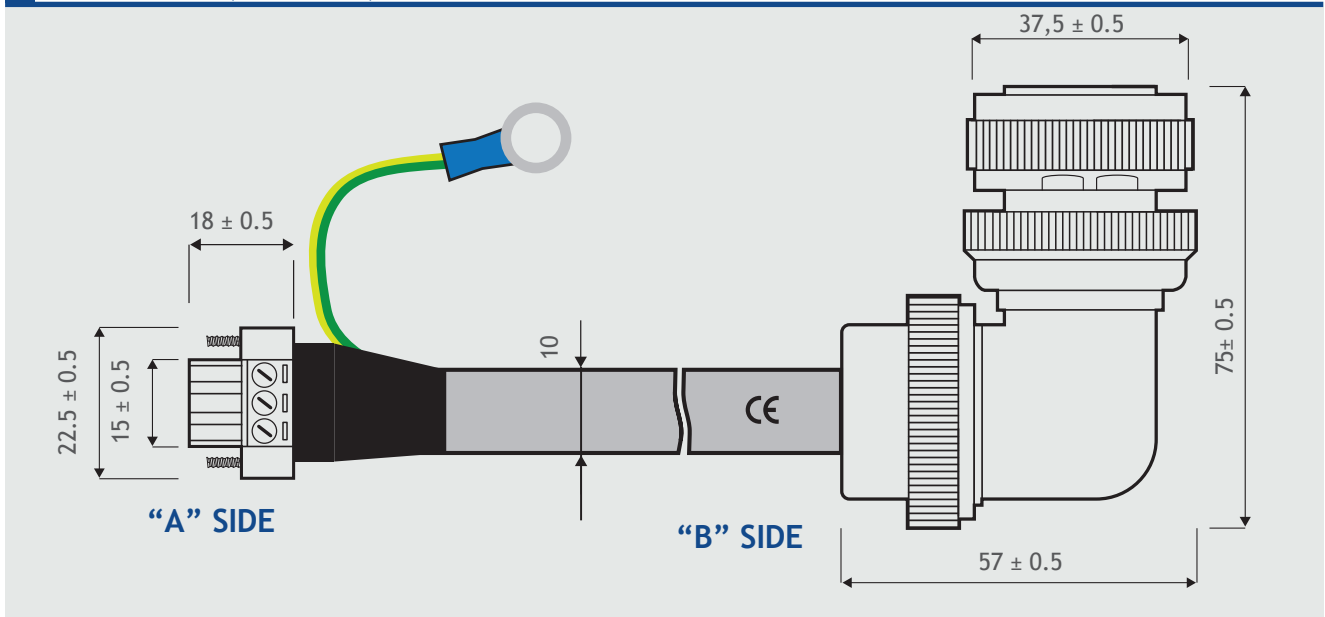

CABLE FEATURES

Cable diameter (mm)	9,2
Shielded	Yes
Flex chain	No
Curvature radius (xØ)	/
Cable speed (m/s)	/
Available lengths (m)	1, 2, 3, 5, 10
International Standard	RoHS, CE

"A" SIDE

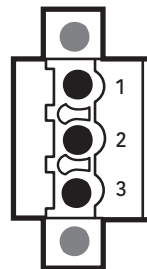

"B" SIDE

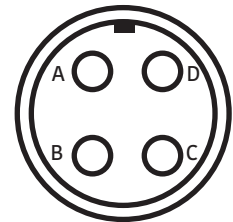

CONNECTORS FEATURES

DRIVE SIDE

CONNECTOR PHOENIX MSTBT2.5/3-STF-5.08

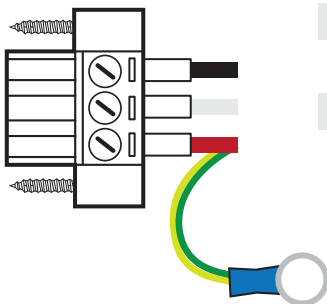

1 [U]

2 [V]

3 [W]

EARTH CABLE

CABLE

WIRE

RED

WHITE

BLACK

SHIELD

MOTOR SIDE

CONNECTOR EUMAX XMS3108E20-4SG

A DISEGNO

B

C

D

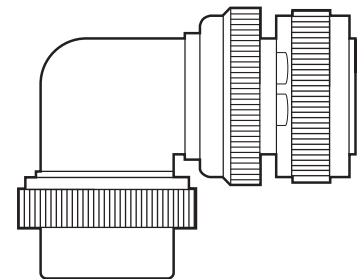

R.T.A. Srl
T +39 0382 929 855
www.rta.it
info@rta.it

R.T.A. Deutschland GmbH
T +49 211 74966860
www.rta-deutschland.de
info@rta-deutschland.de

R.T.A. IBERICA
T +34 936 388805
www.rta-iberica.es
info@rta-iberica.es

R.T.A. INDIA Pvt LTD
T +91 9422507445
www.rta-india.in
info@rta-india.in